

PFM Step-down Single-cell NiZn Battery Charger IC CN3601

General Description:

CN3601 is a fixed off-time PFM mode step-down battery charge management IC with operating voltage range between 2.7V to 6.5V. It is specially designed for single-cell NiZn battery charge management with fewer external components.

CN3601 adopts constant current and maintenance mode to charge battery.

On power up, CN3601 enters constant current charging mode, the on-chip P-channel MOSFET is turned on, inductor current rises. When inductor current reaches upper threshold, the P-channel MOSFET is turned off, a low-side switch is turned on, inductor is discharged, then the P-channel MOSFET is turned on again after 1.5 μ s off time. When battery voltage rises to 1.77V (Typ.), CN3601 enters maintenance mode, in which the inductor current's upper threshold is reduced, in the meantime a timer is started. The charge process will not be terminated until the time out occurs or battery voltage reaches its highest value. In termination mode, the P-channel MOSFET is turned off, there is no current flowing into battery. When BAT pin voltage falls below recharge threshold, the CN3601 enters charge mode again. CN3601's switching frequency can be up to 500KHz, which makes a small-profile inductor usable.

The other features include 2 open-drain status indications, chip over temperature protection, inductor current's upper threshold selection, etc. CN3601 is available in thermally-enhanced 8-pin eSOP package.

Applications:

- Standalone NiZn Battery Charger
- Flashlight
- Toys
- Car Models

Features:

- Input Voltage Range: 2.7V to 6.5V
- Operating Current: 320 μ A@VIN=5V
- Suitable for Solar Panel-Powered Applications
- Switching Frequency up to 500KHz
- Maintenance Charge Mode to Guarantee Fully-charged Battery
- Selectable Upper Threshold of Inductor Current
- Charging terminated by Timer or Battery Voltage
- Automatic Recharge
- Automatic Adaptability to Input Supply with Limited Driving Capability
- Battery Overvoltage Protection
- Over Temperature Protection
- 2 Open-drain Status Indications
- Operating Temperature : -40 $^{\circ}$ C to 85 $^{\circ}$ C
- Available in eSOP8 Package
- Lead-free, rohs-Compliant and Halogen Free

Pin Assignment

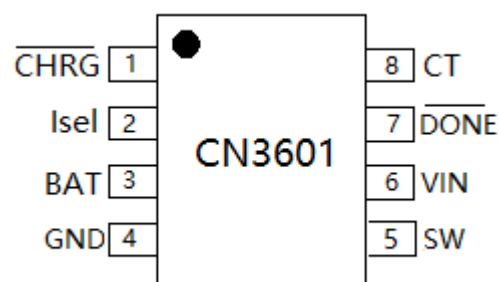

CONSONANCE

Typical Application Circuit:

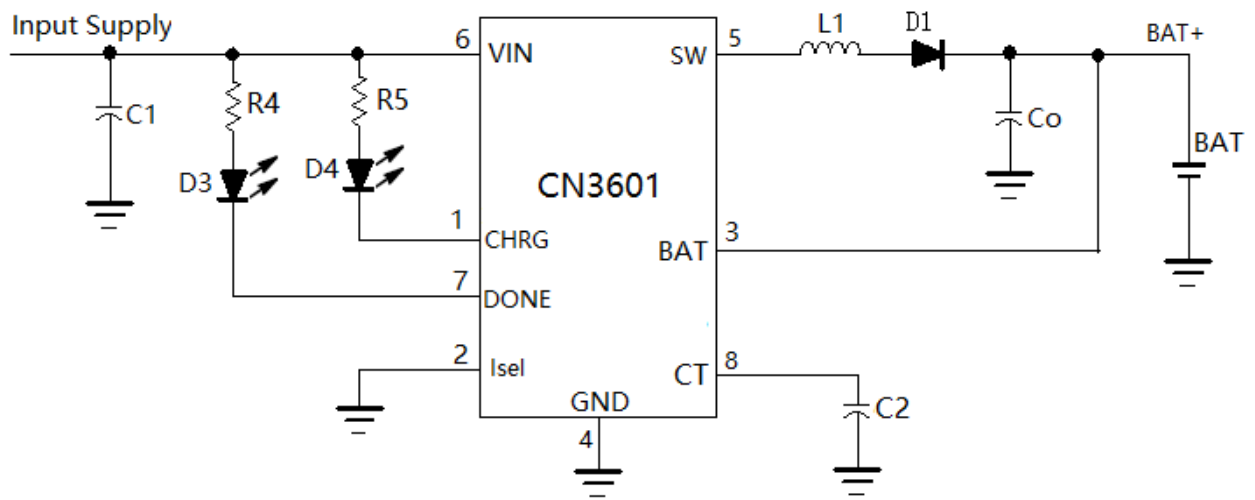

Figure 1 Typical Application Circuit

Ordering Information:

Part No.	Package	Shipping	Operating Temperature
CN3601	eSOP-8	Tape and Reel, 4000/reel	-40°C to 85°C

CONSONANCE

Pin Description:

No.	Symbol	Description
1	$\overline{\text{CHRG}}$	Open-Drain Charge Status Output. When the battery is being charged, this pin is pulled low by an internal switch. Otherwise this pin is in high impedance state.
2	Isel	The Selection Pin of Upper Threshold of Inductor Current. A high input will set the upper threshold of inductor current in constant current mode at 1.19A(Typical); A low input will set the upper threshold of inductor current in constant current mode at 0.62A. The Isel pin can be driven by TTL or CMOS logic level.
3	BAT	Battery Positive Terminal Input. Battery voltage is feedback to the CN3601 through this pin. The CN3601 determines the charge mode based on the BAT pin voltage.
4	GND	Ground. The negative terminal of input supply and battery.
5	SW	Inductor Connection Pin. The inductor is tied to this pin. Internally SW pin is connected to a P-Channel MOSFET and an N-Channel MOSFET.
6	VIN	Positive Terminal of Input Supply. CN3601's internal circuit is powered by this pin.
7	$\overline{\text{DONE}}$	Open-Drain Charge Termination Output. When the charging is terminated, this pin is pulled low by an internal switch. Otherwise this pin is in high impedance state.
8	CT	Timing Capacitor Connection Input. The timing capacitor should be connected between CT pin and GND. The timing function is started once CN3601 enters maintenance mode, and the timing time is determined by the following equation: $t_{\text{timing}} = 12.18 \times 10^9 \times C2$ Where C2 is the capacitance of capacitor C2 in Figure.1.

ABSOLUTE MAXIMUM RATINGS

VIN and Isel Voltage.....	-0.3V to 7.0V	Maximum Junction Temperature.....	150°C
BAT Voltage.....	-0.3V to 18V	Operating Temperature Range.....	-40°C to 85°C
$\overline{\text{CHRG}}$ and $\overline{\text{DONE}}$ Voltage.....	-0.3V to VIN	Storage Temperature.....	-65°C to 150°C
SW and CT Voltage.....	-0.3V to VIN	Lead Temperature(Soldering, 10s).....	260°C

Stresses beyond those listed under “Absolute Maximum Ratings” may cause permanent damage to the device. These are stress ratings only, and functional operation of the device at these or any other conditions beyond those indicated in the operational sections of the specifications is not implied. Exposure to absolute maximum rating conditions for extended periods may affect device reliability.

CONSONANCE

ELECTRICAL CHARACTERICS:

(VIN = 5V, TA = -40°C to +85°C, Typical values are at TA = +25°C, unless otherwise noted)

Parameters	Symbol	Test Conditions	Min	Typ.	Max	Unit
Input Voltage Range	VIN		2.7		6.5	V
UVLO Threshold	VUVLO				2.65	V
Operating Current	IVIN	V _{BAT} =2.1V, No Switching	250	320	390	uA
Fixed Off-Time	t _{off}	Charge mode	1.2	1.5	1.8	uS
Over Temperature Protection	t _{OTP}			145		°C
Hysteresis of Over Temperature Protection	H _{opt}			21		°C
Inductor Current						
Upper Threshold	I _{peak}	CC	I _{sel} is high	1.19		A
		Maintenance		0.62		
		CC	I _{sel} is low	0.64		
		Maintenance		0.44		
BAT Pin						
Highest Battery Voltage	V _{high}	BAT voltage rises	1.881	1.90	1.920	V
Constant Charge Termination Voltage	V _{CCT}	BAT voltage rises	1.75	1.77	1.79	V
Recharge Threshold	V _{rech}	BAT voltage falls	1.722	1.742	1.762	V
BAT Pin Current	I _{BAT}	V _{BAT} =2.0V	4.7	6.3	8	uA
Over Voltage Threshold	V _{OV}	BAT voltage rises	1.996	2.026	2.056	V
Over Voltage Release Threshold	V _{OVRLS}	BAT voltage falls	1.917	1.947	1.977	
SW Pin						
On-resistance of N-channel MOSFET	R _{dsonN}	N-channel MOSFET is between SW pin and GND		0.3		ohm
On-resistance of P-channel MOSFET	R _{dsonP}	P-channel MOSFET is between SW pin and VIN		0.4		ohm
Isel Pin						
Input Low Voltage	V _L	I _{sel} voltage falls			0.7	V
Input High Voltage	V _H	I _{sel} voltage rises	2.2			V
Input Current	I _L	I _{sel} =GND, VIN=6V	-1			uA
	I _H	I _{sel} =VIN=6V			1	
CHRG Pin						
Sink Current	I _{SINK}	V _{CHRG} =0.3V, charge mode		10		mA
Leakage Current	I _{LEAK}	V _{CHRG} =6V, termination mode			100	nA
DONE Pin						
Sink Current	I _{SINK}	V _{DONE} =0.3V, termination mode		10		mA
Leakage Current	I _{LEAK}	V _{DONE} =6V, charge mode			100	nA

CONSONANCE

Detailed Description:

The CN3601 is a fixed off-time PFM mode step-down charge management IC for single-cell NIZn battery with input voltage range from 2.7V to 6.5V.

The CN3601 is composed of reference voltage, inductor peak current sensing circuit, battery voltage detection circuit, battery over voltage protection circuit, chip over temperature protection, logic control block and MOSFET switch, etc. The CN3601 is ideally suitable for single-cell NIZn battery charging application with fewer external components.

After power-on, CN3601 enters constant current charging mode, $\overline{\text{CHRG}}$ pin outputs low to indicate that the charging is ongoing, the on-chip P-channel MOSFET is turned on, the inductor current rises. When the inductor current rises to the upper threshold, the P-channel MOSFET is turned off, the inductor current begins to fall, the energy stored in the inductor is transferred to the battery and the output capacitor. The P-channel MOSFET's off time is fixed at 1.5 μ s, and after the off time, the external P-channel MOSFET is turned on again, and so forth. The battery voltage is sensed through BAT pin. When the BAT pin voltage reaches 1.77V(Typical), CN3601 enters maintenance mode. In maintenance mode, the upper threshold of inductor current is reduced. Once CN3601 is in maintenance mode, an on-chip timer is started, and the charging will not be terminated until the time out occurs or the battery voltage reaches its highest value. In termination mode, the on-chip P-channel MOSFET is turned off, there is no current flowing to the battery, $\overline{\text{DONE}}$ pin outputs low to indicate the termination mode. when the battery voltage falls below 1.742V(Typical), CN3601 enters constant current mode to start a new charge cycle.

The highest switching frequency of CN3601 can be up to 500KHz, which makes the low-profile inductor usable.

The other functions include selectable upper threshold of inductor current, battery over voltage protection, the chip over temperature protection etc..

The charge profile is illustrated in Figure 2.

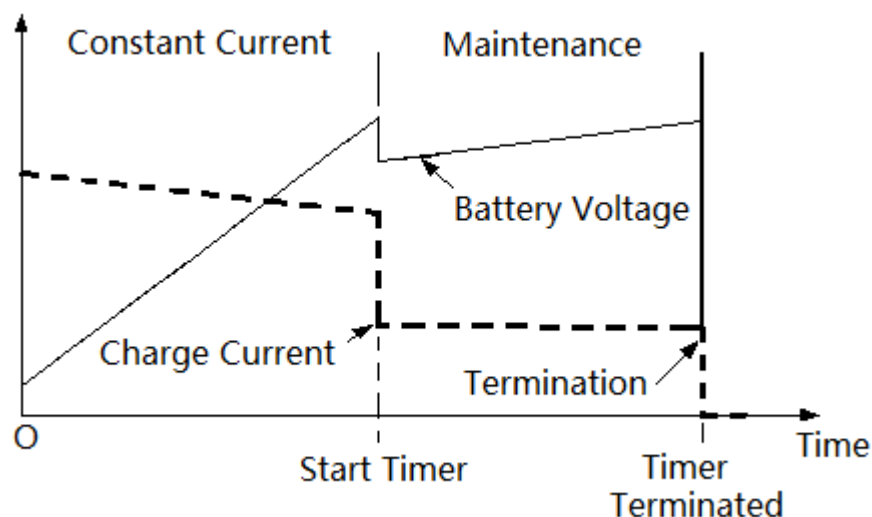

Figure 2 Charging Profile

CONSONANCE

The charging flow is illustrated in Figure 3.

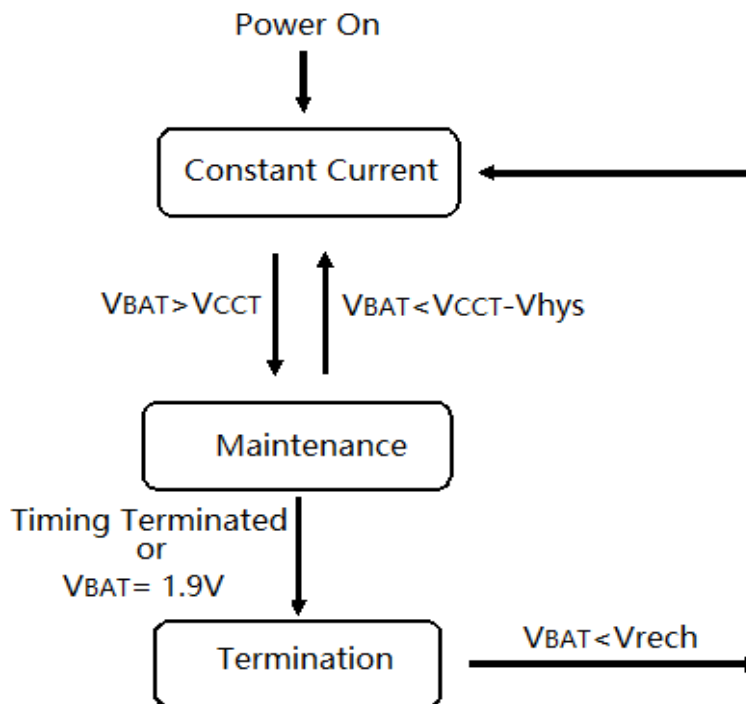

Figure 3 Charging Flow

Application Information:

Input Voltage Range

The CN3601 functions well when the input voltage is between 2.7V to 6.5V. On-chip UVLO circuit will shut down the CN3601 if input voltage falls below UVLO threshold (2.65V Max.).

The Selection of Upper Threshold of Inductor Current

The pin Isel is used to select the upper threshold of inductor current. During the on time of on-chip P-channel MOSFET, inductor current rises, and the P-channel MOSFET is turned off when inductor current reaches its upper threshold set by Isel pin.

The upper threshold of inductor current is listed in the Table 1.

Isel	Charging State	Upper Threshold
High	Constant Current	1.19A
	Maintenance	0.62A
Low	Constant Current	0.64A
	Maintenance	0.44A

Table 1 Upper Threshold of Inductor Current

Do not apply a voltage between 0.7V and 2.2V on Isel pin, otherwise CN3601 may be in uncertain state.

The Highest Battery Voltage

The highest battery voltage is the voltage that the battery may reach during the charge cycle when battery is present, and is internally set at 1.90V(Typical). Once the battery voltage reaches the highest battery voltage, the CN3601 terminates the charge cycle. So this is a protection mechanism to the battery.

When battery is absent, the voltage at BAT pin may be charged to over voltage protection level as CN3601 takes the output capacitor as the battery.

CONSONANCE

Maintenance Charge Mode

If the voltage at BAT pin rises above 1.77V(93.3% of BAT highest voltage), the constant current charge mode is stopped, and the CN3601 goes into the maintenance charge mode. The upper threshold of inductor current in maintenance mode is reduced as shown in Table 1. An internal timer is started once the CN3601 is in the maintenance charge mode, this puts a time limit on the maintenance charge mode, the time limit is programmed by a capacitor at the CT pin as shown in Figure 1. After the time out occurs or the battery voltage rises to its highest value, the whole charge cycle is terminated, the CN3601 enters into termination mode.

In maintenance charge mode, the time limit is determined by the following equation:

$$T = 12.18 \times 10^9 \times C2$$

Where:

- T is the time limit in second
- C2 is the capacitance of C2 in Figure 1, the unit is Farad, C2 should be greater than 1nF, otherwise the timer's accuracy may be affected. If multi-layer ceramic capacitor is used as the timing capacitor, it is better to use 1uF or 2.2uF capacitor whose package size is 0805 or 1206.

Inductor Current and Charge Current Estimation

When the on-chip P-channel MOSFET is on, inductor current rises, when it reaches the upper threshold i_{peak} :

$$I_{peak} = 1.19A \quad (\text{Constant Current Mode})$$

$$I_{peak} = 0.64A \quad (\text{Maintenance Mode})$$

The P-channel MOSFET is turned off, the off-time is fixed at 1.5us(Typical). So the lowest inductor current i_b is decided by the following equation:

$$i_b = i_{peak} - \frac{V_D + V_{BAT}}{L} t_{off}$$

In normal operation, for less EMI emission, inductor L's value should be chosen so that the converter operates in continuous conduction mode in any case, namely i_b must be greater than 0A.

The charge current, also the average inductor current is determined by the following equation:

$$I_{CH} = I_L = i_{peak} - \frac{V_D + V_{BAT}}{2L} t_{off}$$

In the above 2 equations about i_b and I_{CH} ,

i_{peak} is 1.19A for constant current mode, or 0.64A for maintenance mode

V_D is the forward voltage drop of diode D1 in Figure 1

L is the inductance of the inductor L1 in Figure 1

t_{off} is the off time of on-chip P-channel MOSFET, and is fixed at 1.5us Typical

Calculate Switching Frequency

In the application circuit shown in Figure 1, the on-time of on-chip P-channel MOSFET is:

$$t_{on} = \frac{V_{BAT} + V_D}{V_{IN} - V_{BAT} - V_D} t_{off}$$

The off-time t_{off} of the P-channel MOSFET is fixed at 1.5us

So the switching frequency is:

$$f_{sw} = \frac{1}{t_{on} + t_{off}}$$

The switching frequency varies with input voltage and battery voltage

CONSONANCE

Charge Termination

If voltage at BAT pin reaches 1.90V(Typical) or the time out occurs in maintenance mode, the charge cycle is terminated, the on-chip P-channel MOSFET is turned off, no current flows to battery.

Recharge

In termination mode, if voltage at BAT pin falls below 1.742V(Typical), CN3601 enters charge mode again.

Selection of Inductor

The inductor value should be chosen so that the converter operates in continuous conduction mode(CCM) in any case for less EMI emission.

Table 2 lists the recommended inductor value:

Conditions	Inductor Value
I _{sel} is always high	15uH
I _{sel} being low may be the case	22uH
Powered by solar panel	47uH, 100uH or larger to ensure in CCM

Table 2 Inductor Value

The inductor's saturation current should be greater than 1.5A.

Selection of Diode

The diode D1 in Figure 1 is used to prevent battery current from flowing backwards. The forward voltage of the diode should be as low as possible for better efficiency. A Schottky diode is a good choice. The forward current rating of the diode must be at least 1.5A.

Input Capacitor

In most applications, a bypass capacitor at VIN is needed. An at least 4.7uF ceramic capacitor, placed in close proximity to VIN and GND pins, works well. In some applications depending on the power supply characteristics and cable length, it may be necessary to increase the capacitor's value. The capacitor's breakdown voltage should be higher than the maximum input voltage.

Generally a capacitor between 4.7uF and 20uF works well, ceramic capacitor of X5R or X7R is highly recommended.

Output Capacitor

A filter capacitor (C_o in Figure 1) is needed between battery positive terminal and ground, the capacitor also supply energy to battery when the P-channel MOSFET is in off state.

Generally a capacitor of 10uF works well, the ESR of the output capacitor should be as small as possible, X5R or X7R capacitors are recommended.

Over Temperature Protection

The CN3601 adopts on-chip over temperature protection function. If the silicon temperature is over 145°C, the P-channel MOSFET is turned off, no energy is transferred to inductor or battery until the silicon temperature falls below 124°C again.

Battery Absence

When the battery is not present, the CN3601 takes the output capacitor as battery and charges it quickly to over voltage protection level, then the battery voltage decays slowly to over voltage release threshold because of low battery current, so the CN3601 will toggle between charge and over voltage protection mode, which results in a sawtooth waveform at battery positive terminal.

Open-Drain Status Outputs

The CN3601 has 2 open-drain status outputs: \overline{DONE} and \overline{CHRG} . \overline{CHRG} is pulled low when the charger is in charging status, otherwise \overline{CHRG} becomes high impedance. \overline{DONE} is pulled low if the charger is in termination status, otherwise \overline{DONE} becomes high impedance.

CONSONANCE

In any case, if over voltage state is asserted, both $\overline{\text{CHRG}}$ and $\overline{\text{DONE}}$ output high impedance.

If over temperature state is asserted in charge mode, both $\overline{\text{CHRG}}$ and $\overline{\text{DONE}}$ output high impedance. If over temperature state is asserted in termination mode, $\overline{\text{CHRG}}$ still outputs high impedance, and $\overline{\text{DONE}}$ is pulled low. If battery is not present, both $\overline{\text{CHRG}}$ and $\overline{\text{DONE}}$ output high impedance.

Self-adaptive Function to Input Supply

CN3601 can adjust the charge current automatically to adapt the input supply's output capability. This feature makes it possible that the circuit design can be done based on the adaptor with strong output capability for quick charge purpose, while the adaptor with weaker output capability can also be used for charge purpose.

This feature also makes CN3601 can be powered by solar panel.

Design Procedures

The following design procedures can be followed to design the parameters of CN3601 application circuit:

- (1) To determine the charge current according to the battery capacity and the requirement of charge time. There are only 2 choices of charge current by pulling Isel pin to high or to low.
- (2) To determine the timing time
In maintenance mode, empirically an amount of energy of 40% of battery capacity should be charged into battery. Suppose battery capacity is C, so the timing time should be:

$$T = 0.4C / I_{CH}$$

Where, I_{CH} is the charge current in maintenance mode

$$I_{CH} = I_L = i_{peak} - \frac{V_D + V_{BAT}}{2L} t_{off}$$

- (3) To decide the capacitor C2 based on the timing time.
Timing time $T = 12.18 \times 10^9 \times C2$
- (4) To select inductor value according to Table 2
- (5) To decide the input capacitor based on the input supply's characteristics, input supply's cable length and input current.
- (6) To select diode. A schottky diode is a good choice.
- (7) To select the output capacitor. A 10uF to 20uF ceramic capacitor works well for the purpose.

PCB Considerations

A good PCB design is very important to efficiency and performance. When laying out the printed circuit board, the following considerations should be taken to ensure proper operation of the IC.

- Use double-layer PCB for better performance.
- The ground connections of output capacitor, CN3601 GND need to feed into same copper that connects to the input capacitor ground before tying back into system ground. This copper should be as wide as possible, and back to system ground separately.
- To minimize radiation, the diode, inductor and the input bypass capacitor traces should be kept as short as possible.

CONSONANCE

Package Information

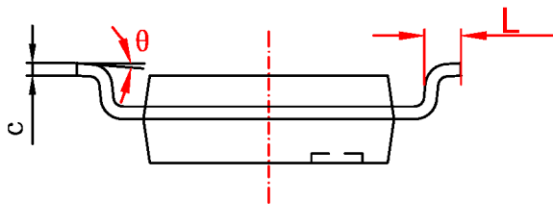
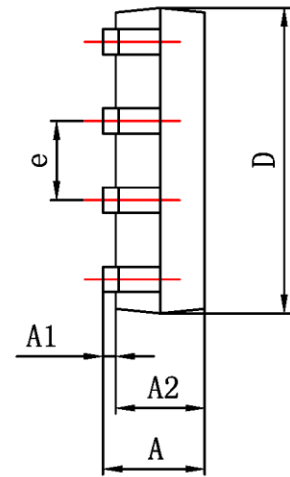
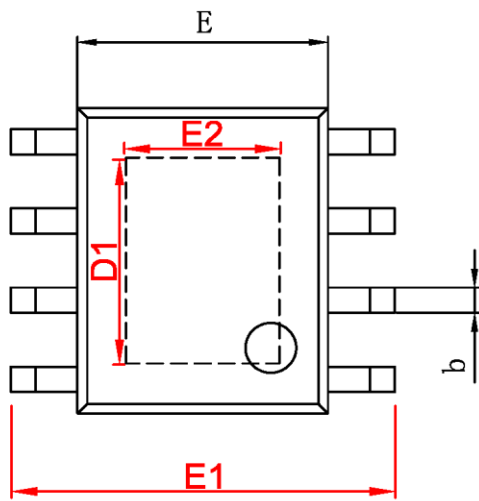

字符	Dimensions In Millimeters		Dimensions In Inches	
	Min	Max	Min	Max
A	1.350	1.750	0.053	0.069
A1	0.050	0.150	0.004	0.010
A2	1.350	1.550	0.053	0.061
b	0.330	0.510	0.013	0.020
c	0.170	0.250	0.006	0.010
D	4.700	5.100	0.185	0.200
D1	3.202	3.402	0.126	0.134
E	3.800	4.000	0.150	0.157
E1	5.800	6.200	0.228	0.244
E2	2.313	2.513	0.091	0.099
e	1.270 (BSC)		0.050 (BSC)	
L	0.400	1.270	0.016	0.050
θ	0°	8°	0°	8°

Consonance Electronics does not assume any responsibility for use of any circuitry described. Consonance Electronics reserves the right to change the circuitry and specifications without notice at any time.