



SILERGY



Application Note:SY7711

1 Channel Boost LED Controller

General Description

The SY7711 is a boost LED controller targeted for WLED backlight application. The device has a wide input voltage range of 5V to 28V. The converter uses pseudo constant frequency control mode to improve system stability. The PWM dimming function allows accurate LED analog current control.

Features

- V_{CC} supply voltage range: 5V to 28V
- 120kHz switching frequency
- PWM analog dimming: 10kHz~1MHz
- Output over voltage protection(OVP)
- Over current protection(OCP)
- LED open & short protection
- LED cathode short to GND protection
- Inductor short & diode open/short protection
- Thermal shutdown protection(OTP)
- -40 to +85 C° temperature range
- Pb-free Package: SOT23-6

Ordering Information

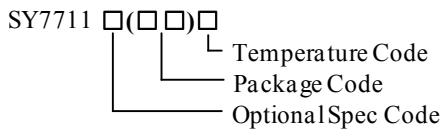

Ordering Number	Package Type	Note
SY7711ABC	SOT23-6	-----

Applications

- LCD TV Backlight
- LCD Monitor Backlight

Typical Applications

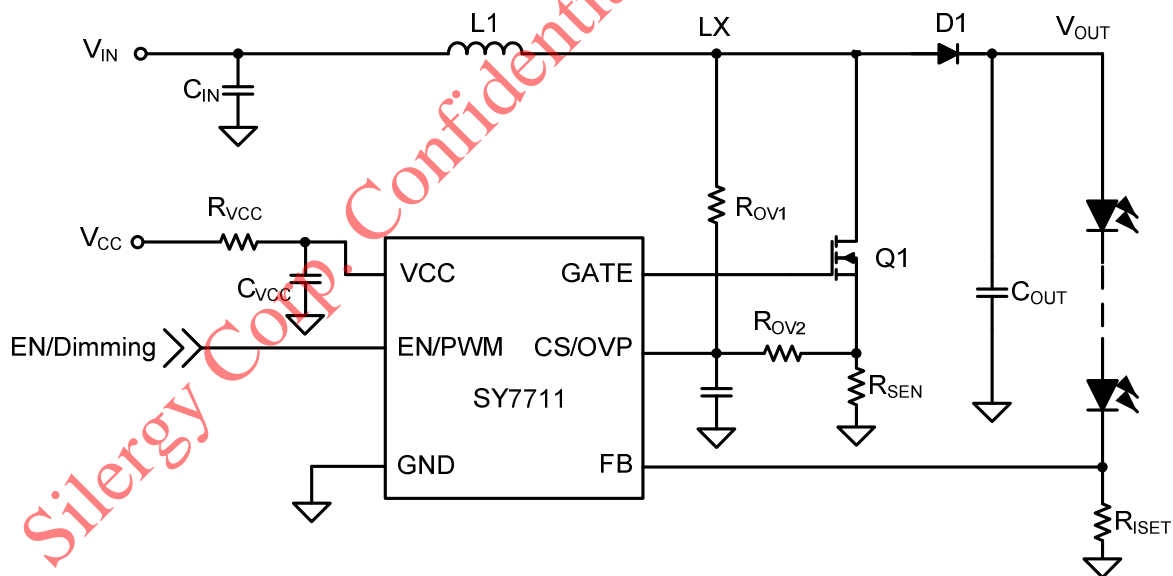
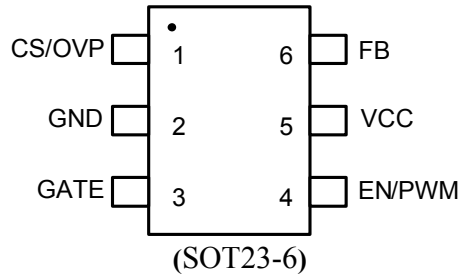

Fig.1 schematic

Pinout (top view)



Top Mark: Tfxyz (Device code: Tf, x=year code, y=week code, z=lot number code)

Pin Name	Pin Number	Pin Description
CS/OVP	1	Dual function for boost MOSFET current sensing and output over voltage protection.
GND	2	Ground pin.
GATE	3	Driver pin. Connect to the gate of boost MOSFET.
EN/PWM	4	Enable and PWM dimming control. When used as enable input, pull high to turn on IC. When used as dimming input, the first pulse should be longer than 200ns to turn on IC. And the recommend dimming frequency range is 10kHz~1MHz.
VCC	5	Input pin. Decouple this pin to ground with a MLCC of at least 1μF.
FB	6	Feedback pin. The LED current equals to: $I_{LED} = V_{FB} / R_{ISET}$.

Absolute Maximum Ratings (Note 1)

VCC, EN/PWM, GATE, FB	30V
CS/OVP	3.6V
Power Dissipation, Pd @ TA = 25°C, SOT23-6	0.6W
Package Thermal Resistance (Note 2)	
SOT23-6 θJA	208°C/W
SOT23-6 θJC	45°C/W
Junction Temperature Range	150°C
Lead Temperature (Soldering, 10 sec.)	260°C
Storage Temperature Range	-65°C to 150°C

Recommended Operating Conditions (Note 3)

VCC	5V to 28V
Ambient Temperature Range	-40°C to 85°C



Electrical Characteristics

($T_A = 25^\circ\text{C}$, $V_{CC}=12\text{V}$, $C_{VCC}=1\mu\text{F}$, unless otherwise specified)

Parameter	Symbol	Test Conditions	Min	Typ	Max	Unit
Power Supply Range	V_{CC}		5		28	V
Quiescent Current	I_Q	EN/PWM=high level FB =0.5V		250		μA
Shutdown Current	I_{SD}	EN/PWM=low level		5		μA
V_{CC} UVLO Rising Threshold	V_{CCUVLO}				4.95	V
V_{CC} UVLO Hysteresis	$V_{CCUVLOHYS}$	Falling edge		500		mV
FB Reference Voltage	V_{FB}		392	400	408	mV
FB Reference Voltage (PWM Analog Dimming)	V_{FBDim}	PWM Duty cycle=10%, $F_{PWM}=10\text{kHz}$	38	40	42	mV
LED Short Circuit Rising Threshold	$V_{FBLatch}$			1		V
Boost Switching Frequency	F_{sw}			120		kHz
Gate Driver Output High Level	Gate _H	High level		10		V
Gate Driver Source Current	I_{SOURCE}	Peak current		1.25		A
Gate Driver Sink Current	I_{SINK}	Peak current		2		A
CS Limit Reference Voltage	V_{CSREF}		180	200	220	mV
CS Latch Off Threshold	$V_{CSLatch}$			500		mV
OVP Latch Off Triggered Threshold	$V_{OVPLatch}$		180	200	220	mV
EN/PWM High Level	V_H		1.5			V
EN/PWM Low Level	V_L				0.4	V
Thermal Shutdown Temperature	T_{SD}			150		$^\circ\text{C}$
Thermal Shutdown Hysteresis				20		$^\circ\text{C}$

Note 1: Stresses beyond the “Absolute Maximum Ratings” may cause permanent damage to the device. These are stress ratings only. Functional operation of the device at these or any other conditions beyond those indicated in the operational sections of the specification is not implied. Exposure to absolute maximum rating conditions for extended periods may affect device reliability

Note 2: θ_{JA} is measured in the natural convection at $T_A= 25^\circ\text{C}$ on a low effective single layer thermal conductivity test board of JEDEC 51-3 thermal measurement standard.

Note 3. The device is not guaranteed to function outside its operating conditions

Typical Performance Characteristic

($V_{IN} = V_{CC} = 12V$, $I_{LED} = 250mA$, 20 PCS LED Series)

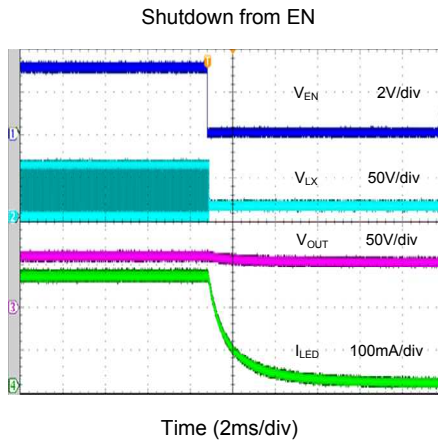
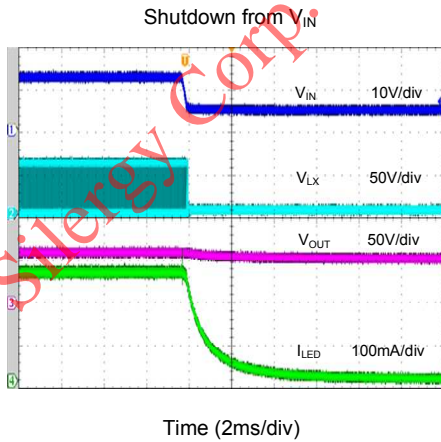
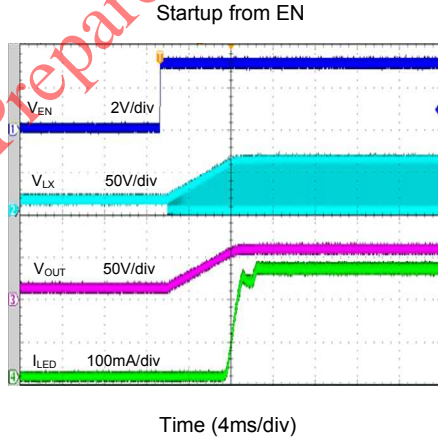
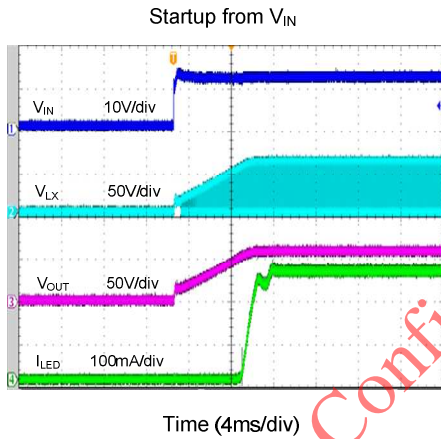
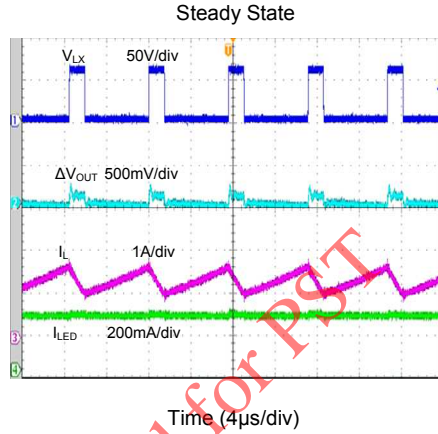
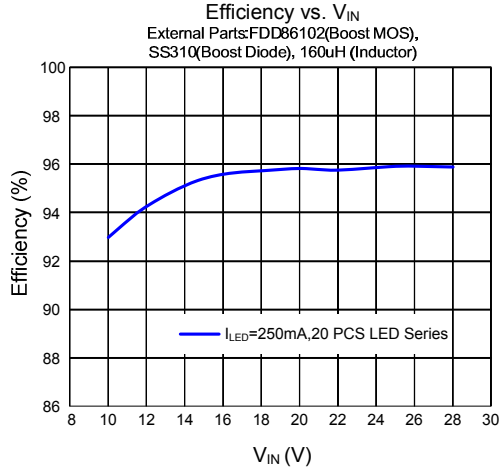

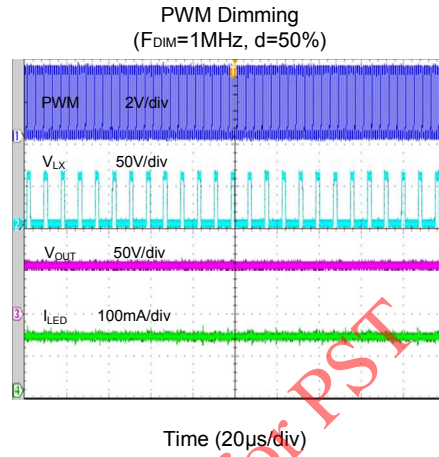
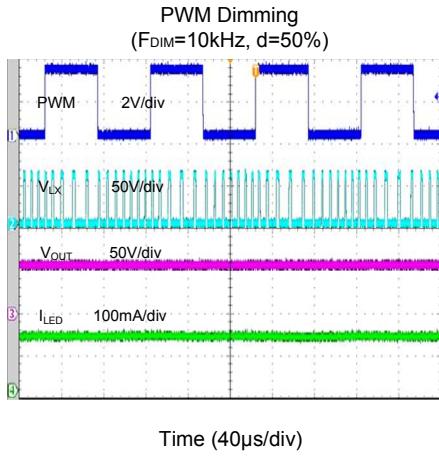

Silergy Corp. Confidential-Prepared for PST

Function Description

SY7711 is a boost LED controller targeted for white WLED application. It integrates compensation network to achieve the minimum solution footprint.

The IC provides comprehensive protection function such as output over voltage protection (OVP), over current protection (OCP), LED open & short protection, LED cathode short to GND protection, inductor & diode short/open protection, thermal shutdown protection.

LED Current Setting

LED current is programmed by a resistor which is in series with the LED string. LED current is calculated as:

$$I_{LED} = V_{FB} / R_{ISET}$$

PWM Analog Dimming

When the EN/PWM pin is constantly high, the FB voltage is regulated to 400mV (Typ). The EN/PWM pin allows a PWM signal to reduce the regulation voltage, therefore, it achieves LED brightness dimming. The PWM signal changes the FB regulation voltage by adjusting PWM duty cycle. The relationship between the duty cycle and FB voltage is calculated as: $V_{FB} = 400mV \times \text{PWM Duty}$. It is recommended that the PWM signal frequency is higher than 10kHz.

Output Over Voltage and LED Open Protection

Choose proper resistor R_{OV1} and R_{OV2} to program the output voltage protection point. V_{OVP} is calculated as:

$$V_{OVP} = 0.2V \times (1 + R_{OV1} / R_{OV2})$$

Make sure the upper resistor (R_{OV1}) will not exceed its power rating when output voltage reaches the OVP point. If LED string is open, FB voltage will be pulled to ground. The boost converter continues charging the output voltage until OVP threshold is triggered.

If the voltage on CS/OVP pin during Gate off time exceeds 200mV (Typ) for 4 cycles, IC will latch off.

Over Current Protection

An external sensing resistor R_{SEN} is used to sense the current flow through the boost MOSFET. The sensed voltage is used for peak current mode control and cycle by cycle peak current limit. Peak current limit will be triggered when the voltage on CS/OVP pin exceeds CS limit reference voltage 200mV (Typ). It is desirable to make the maximum value of CS sensing voltage to be about 70% of CS limit reference voltage during normal operation. Thus,

$$R_{SEN} = \frac{70\% \times 0.2V}{I_{PEAK}}$$

I_{PEAK} is the peak current through boost MOSFET (A).

LED Short Protection

If LED anode and cathode is short, the FB voltage will increase from regulation voltage to a higher value. If the FB voltage exceeds LED short circuit rising threshold 1V (Typ), IC will latch off.

LED Cathode Short to GND Protection

If LED cathode is shorted to GND, the FB voltage will drop. The boost converter continues charging the output voltage until OVP threshold is triggered. In some condition, OCP will be triggered firstly before OVP is triggered. Thus the IC will sustain on OCP state and not latch off immediately.

If the peak current sensing voltage V_{CS} exceeds 200mV (Typ) and FB voltage is less than 50mV, both above condition lasts for 512 duty cycle, IC will latch off.

Inductor & Diode Short Protection

When boost inductor or diode is short, the current of the boost MOSFET will increase dramatically. If the peak current sensing voltage V_{CS} exceeds 0.5V (Typ), IC will latch off.

Thermal Shutdown Protection

When the IC junction temperature reaches 150°C, the IC will shut down. The IC will not start up again until the junction temperature falls below +130°C or the power input is recycled.

Applications Information

Inductor L:

There are several considerations in choosing this inductor.

1) Choose the inductance to provide the desired ripple current. It is suggested to choose the ripple current to be about 40% of the maximum average input current. The inductance is calculated as:

$$L = \left(\frac{V_{IN}}{V_{OUT}} \right)^2 \frac{(V_{OUT} - V_{IN})}{F_{SW} \times I_{OUT,MAX} \times 40\%}$$

where F_{SW} is the switching frequency and $I_{OUT,MAX}$ is the maximum LED current.

2) The saturation current rating of the inductor must be selected to be greater than the peak inductor current under full load conditions.

$$I_{SAT,MIN} > \left(\frac{V_{OUT}}{V_{IN}} \right) \times I_{OUT,MAX} + \frac{(V_{OUT} - V_{IN})}{2 \times F_{SW} \times L} \times \left(\frac{V_{IN}}{V_{OUT}} \right)^2$$

3) The DCR of the inductor and the core loss at the switching frequency must be low enough to achieve the desired efficiency requirement.

Input capacitor C_{IN}:

The ripple current through input capacitor is calculated as:

$$I_{CIN_RMS} = \frac{V_{IN} \cdot (V_{OUT} - V_{IN})}{2\sqrt{3} \cdot L \cdot F_{SW} \cdot V_{OUT}}$$

To minimize the potential noise problem, place a typical X7R or better grade ceramic capacitor really close to the IN and GND pins.

Output capacitor C_{OUT}:

The output capacitor is selected to handle the output ripple noise requirements. Both steady state ripple and transient requirements must be taken into consideration when selecting output capacitor. The voltage rating of the output capacitor should be higher than the maximum output voltage. The minimum required capacitance can be calculated as:

$$C_{OUT} = \frac{I_{LED} \times (V_{OUT} - V_{IN})}{F_{SW} \times V_{OUT} \times V_{RIPPLE}}$$

V_{RIPPLE} is the peak to peak output ripple. For LED applications, the equivalent resistance of the LED is typically low. The output capacitance should be large enough to attenuate the ripple current through LED.

Layout Design:

Proper PCB layout and components placement are critical to the performance of the IC and to prevent noise and electromagnetic interference problems. Following are some rules for the PCB layout:

- 1) The loop of boost MOSFET, rectifier diode, and output capacitor must be as short as possible.
- 2) It is desirable to maximize the PCB copper area connecting to GND pin to achieve the best thermal and noise performance.
- 3) C_{VCC} must be close to VCC pin and GND pin. The loop area formed by C_{VCC} and GND must be minimized.
- 4) The PCB copper area associated with LX node must be minimized to avoid the potential noise problem.

SOT23-6 Package outline & PCB layout design

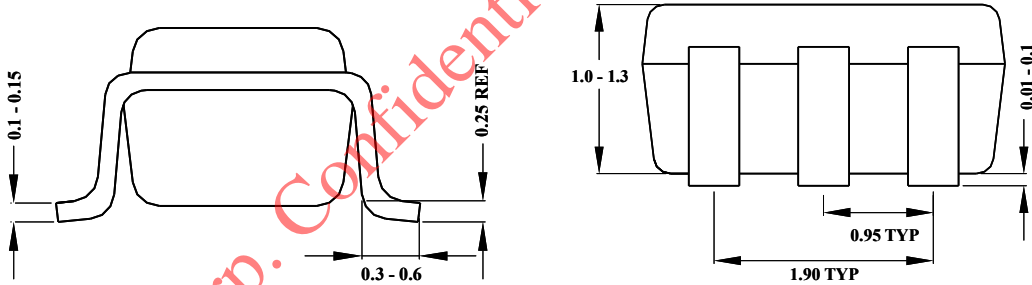
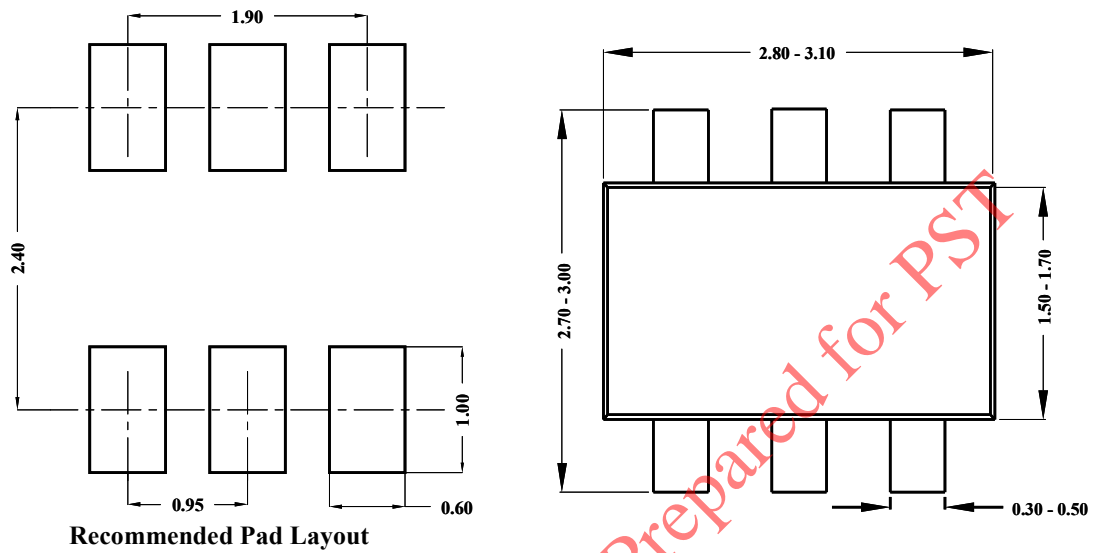

Notes: All dimensions are in millimeters.
All dimensions don't include mold flash & metal burr.

Taping & Reel Specification

1. Taping orientation

SOT23-6

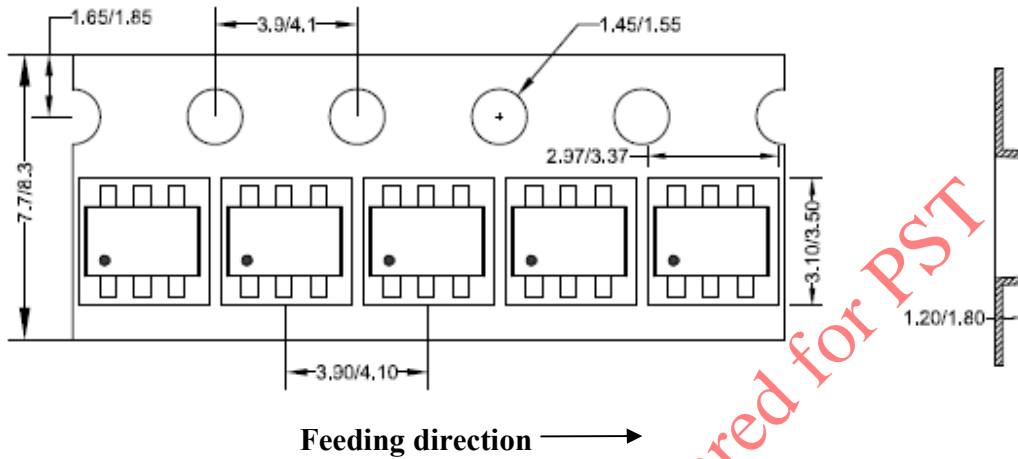

2. Carrier Tape & Reel specification for packages

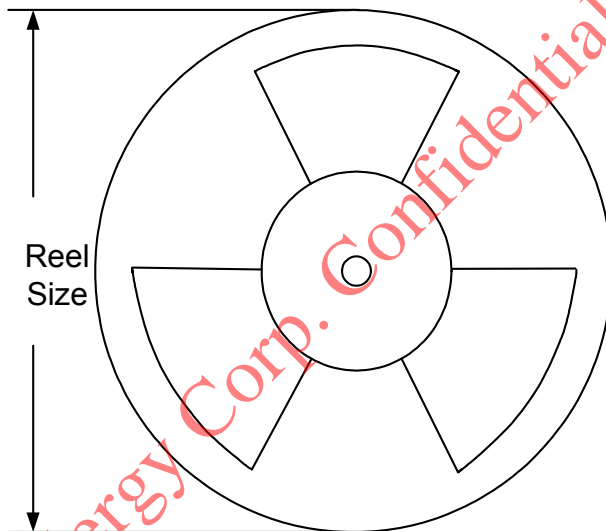

Package types	Tape width (mm)	Pocket pitch(mm)	Reel size (Inch)	Trailer length(mm)	Leader length (mm)	Qty per reel
SOT23-6	8	4	7"	280	160	3000

3. Others: NA