

**SURFACE MOUNT UNIDIRECTIONAL TRANSIENT VOLTAGE SUPPRESSORS**

STAND-OFF VOLTAGE - 5.0 to 24 Volts  
POWER DISSIPATION - 200 WATTS

**FEATURES**

- For surface mounted applications
- Reliable low cost construction utilizing molded plastic technique
- Plastic material has UL flammability classification 94V-0
- Typical IR less than 1uA above 10V
- Fast response time: typically less than 1.0ns
- IEC6100-4-2, Level 4(ESD), >15KV(air); >8KV(Contact)
- RoHS compliant

**MECHANICAL DATA**

- Case Material: "Green" molding compound, UL flammability classification 94V-0, (No Br. Sb. Cl.)
- Polarity : Cathode designated by TAB1
- Weight : 15.5 mg

**DO-216AA**

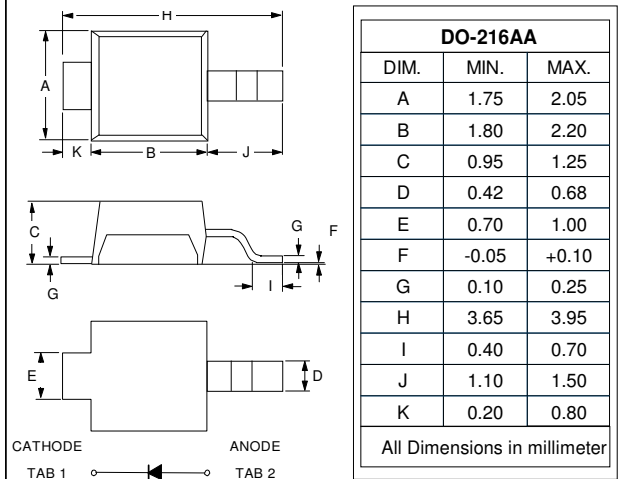

**MAXIMUM RATINGS AND ELECTRICAL CHARACTERISTICS**

Ratings at 25°C ambient temperature unless otherwise specified.  
Single phase, half wave, 60Hz, resistive or inductive load.  
For capacitive load, derate current by 20%

CHARACTERISTICS	SYMBOLS	VALUE	UNIT
PEAK POWER DISSIPATION AT T <sub>J</sub> = 25 °C, T <sub>P</sub> = 1ms (Note 1)	P <sub>PK</sub>	Minimum 200	WATTS
Non repetitive Peak Forward Surge Current 8.3ms single half sine-wave @ T <sub>J</sub> = 25 °C	I <sub>FSM</sub>	25	AMPS.
Power Dissipation on infinite heatsink @T <sub>A</sub> =100 °C	P <sub>M(AV)</sub>	2.5	WATTS
Typical Thermal Resistance (Note 2) (Note 3)	R <sub>θJT</sub> R <sub>θJA</sub>	20 250	°C/W
Operating Temperature Range	T <sub>J</sub>	-55 to +175	°C
Storage Temperature Range	T <sub>STG</sub>	-55 to +175	°C

NOTES : 1. Non-repetitive current pulse, per Fig. 3 and derated above T<sub>J</sub>= 25 °C per Fig.1.  
2. Thermal Resistance Junction to Tab.  
3. Thermal Resistance Junction to ambient on PCB with recommended pad layout

FIG.1 - PEAK PULSE POWER DERATING CURVE

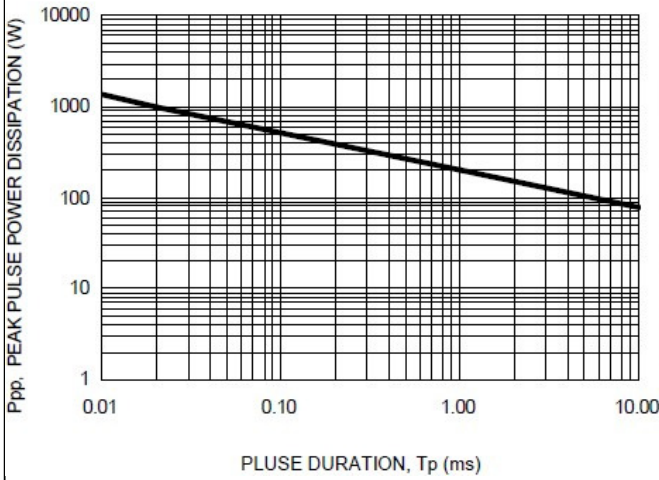

FIG.2 - PEAK PULSE POWER DERATING CURVE

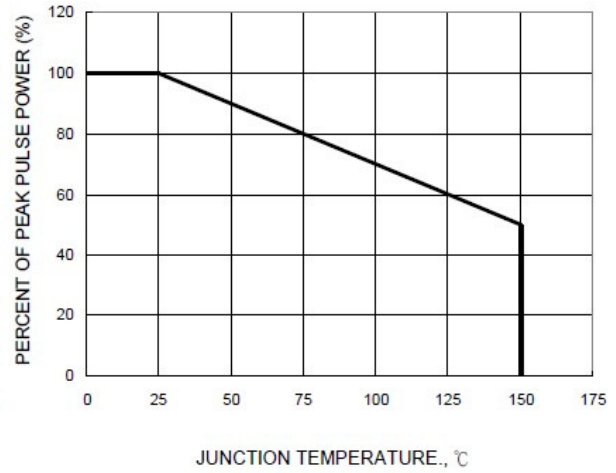

FIG.3 - PULSE WAVEFORM

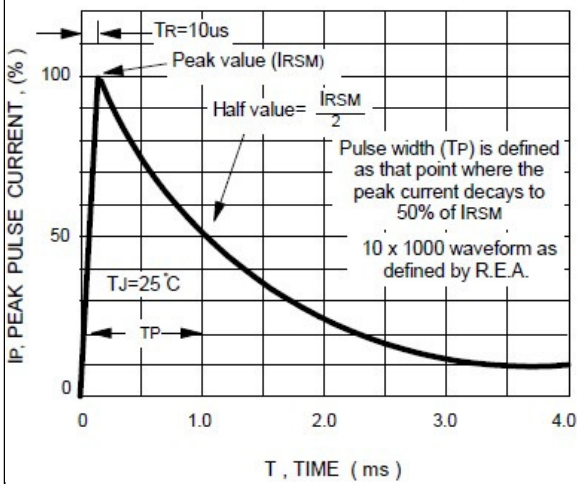

FIG.4 - TYPICAL REVERSE CHARACTERISTICS

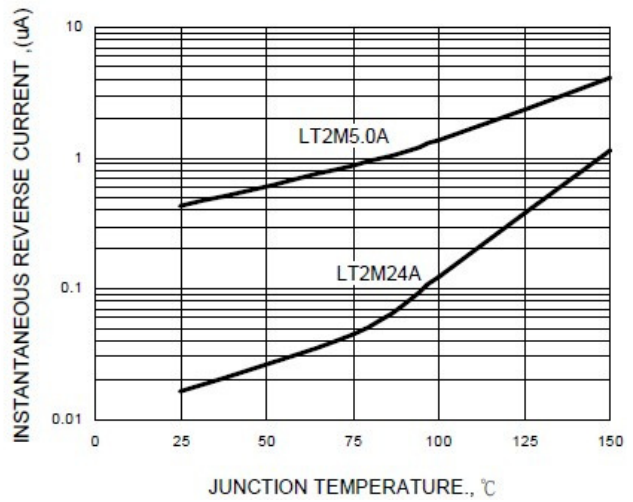

FIG.5 - AVERAGE POWER DERATING CURVE

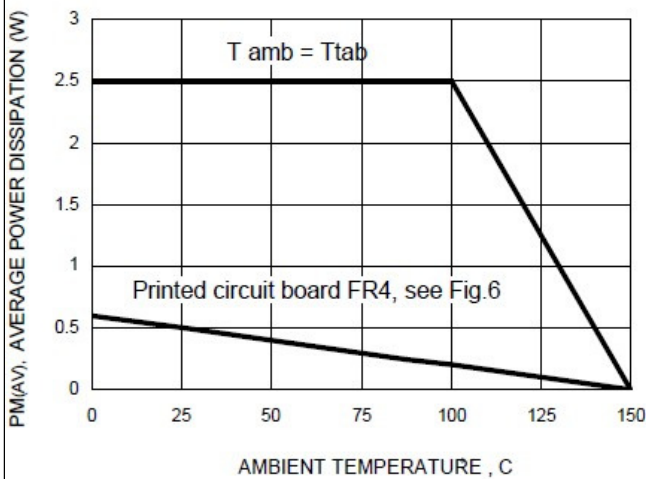
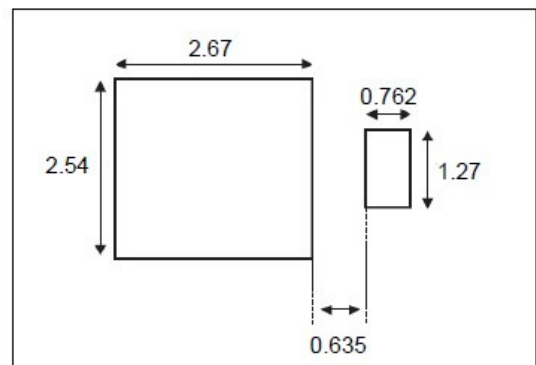

FIG.6 - FOOT PRINT DIMENSION Print (mm)



Device Uni-directional	Marking	Working Peak Reverse Voltage	Breakdown voltage VBR Volts			Maximum Reverse Leakage at VRWM	Maximum Reverse Surge Current	Maximum Reverse Voltage at IRSM (Clamping Voltage)	Off-State Capacitance
			VRWM(Volts)	Min.	Max.				
LT2M5.0A	MNB	5.0	6.40	7.07	10	50	21.7	9.2	850.0
LT2M12A	MNF	12.0	13.3	14.7	1	1	10.1	19.9	330.0
LT2M16A	MNH	16.0	17.1	18.9	1	1	7.7	26.0	260.0
LT2M24A	MNK	24.0	25.7	28.4	1	1	5.1	38.9	180.0

Note: Off-state capacitance measured at f=1.0MHz; 1.0VRMS signal; VR=2VDC bias.

## **Important Notice and Disclaimer**

LSC reserves the right to make changes to this document and its products and specifications at any time without notice. Customers should obtain and confirm the latest product information and specifications before final design, purchase or use.

LSC makes no warranty, representation or guarantee regarding the suitability of its products for any particular purpose, nor does LSC assume any liability for application assistance or customer product design. LSC does not warrant or accept any liability with products which are purchased or used for any unintended or unauthorized application.

No license is granted by implication or otherwise under any intellectual property rights of LSC.

LSC products are not authorized for use as critical components in life support devices or systems without express written approval of LSC.