



US3AB THRU US3MB

Reverse Voltage - 50 to 1000 Volts Forward Current - 3.0 Ampere

SURFACE MOUNT ULTRA FAST RECTIFIER

Features

- ◆ The plastic package carries Underwriters Laboratory Flammability Classification 94V-0
- ◆ For surface mounted applications
- ◆ Ultra fast switching for high efficiency
- ◆ Low reverse leakage
- ◆ Built-in strain relief, ideal for automated placement
- ◆ High forward surge current capability
- ◆ High temperature soldering guaranteed
250 °C/10 seconds at terminals

Mechanical Data

Case : JEDEC DO-214AA/SMB Molded plastic body

Terminals : Solder plated, solderable per MIL-STD-750, Method 2026

Polarity : Polarity symbol marking on body

Mounting Position : Any

Weight : 0.003 ounce, 0.095grams

DO-214AA/SMB

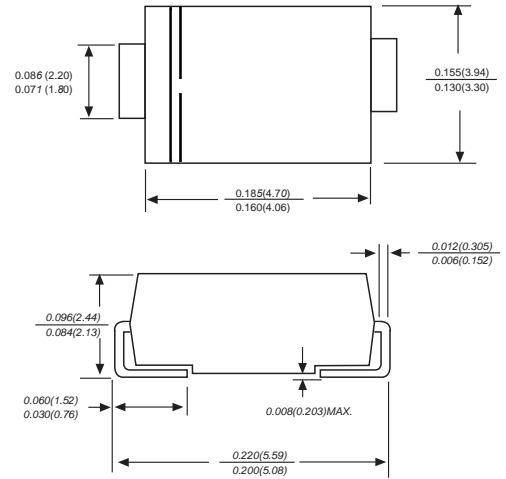

Dimensions in inches and (millimeters)

Maximum Ratings And Electrical Characteristics

Ratings at 25°C ambient temperature unless otherwise specified.

Single phase half-wave 60Hz, resistive or inductive load, for capacitive load current derate by 20%.

Parameter	SYMBOLS	MDD US3AB	MDD US3BB	MDD US3DB	MDD US3GB	MDD US3JB	MDD US3KB	MDD US3MB	UNITS
Marking Code									
Maximum repetitive peak reverse voltage	V_{RRM}	50	100	200	400	600	800	1000	V
Maximum RMS voltage	V_{RMS}	35	70	140	280	420	560	700	V
Maximum DC blocking voltage	V_{DC}	50	100	200	400	600	800	1000	V
Maximum average forward rectified current	$I_{(AV)}$	3							A
Peak forward surge current 8.3ms single half sine-wave superimposed on rated load (JEDEC Method)	I_{FSM}	90							A
Maximum instantaneous forward voltage at 3A	V_F	1			1.3	1.68			V
Maximum DC reverse current at rated DC blocking voltage $T_A=25^\circ C$ $T_A=125^\circ C$	I_R	5 100							μA
Maximum reverse recovery time (NOTE 1)	t_{rr}	50				75			ns
Typical junction capacitance (NOTE 2)	C_J	75				50			pF
Typical thermal resistance (NOTE 3)	$R_{\theta JA}$ $R_{\theta JC}$	45 15							$^\circ C/W$
Operating junction and storage temperature range	T_J, T_{STG}	-55 to +150							$^\circ C$

Note: 1. Reverse recovery condition $I_F=0.5A, I_R=1.0A, I_{rr}=0.25A$
 2. Measured at 1MHz and applied reverse voltage of 4.0V D.C.
 3. P.C.B. mounted with 2.0"x2.0" (5.0x5.0cm) copper pad areas



US3AB THRU US3MB

Reverse Voltage - 50 to 1000 Volts Forward Current - 3.0 Ampere

Ratings And Characteristic Curves

Fig.1 Maximum Average Forward Current Rating

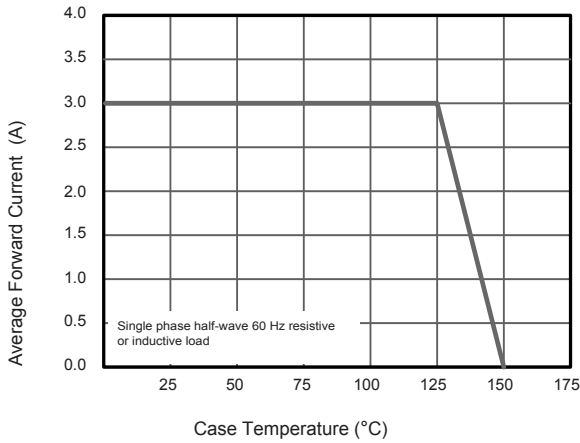

Fig.2 Typical Reverse Characteristics

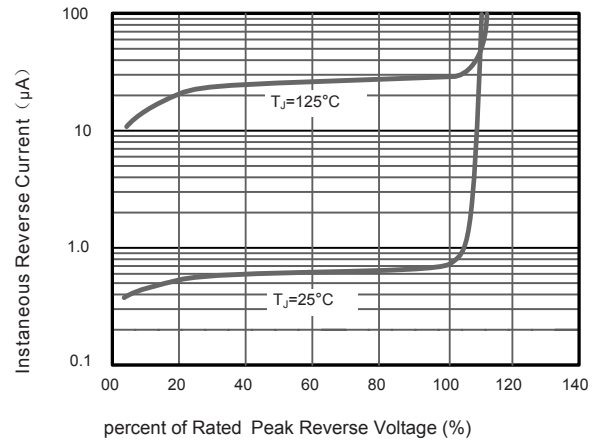

Fig.3 Typical Forward Characteristics

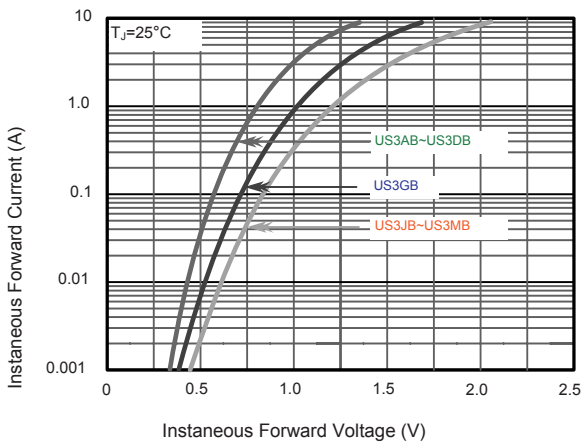
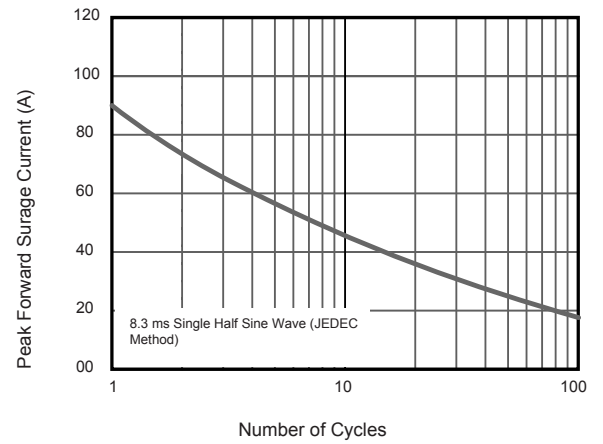

Fig.4 Maximum Non-Repetitive Peak Forward Surge Current



The curve above is for reference only.



US3AB THRU US3MB

Reverse Voltage - 50 to 1000 Volts Forward Current - 3.0 Ampere

Packing information

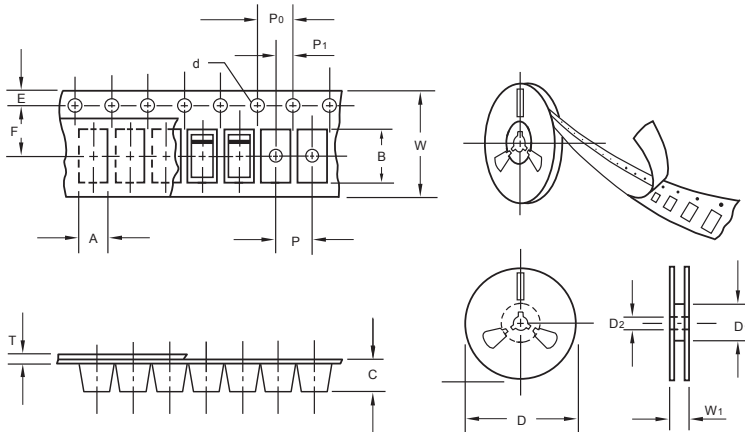

unit:mm

Item	Symbol	Tolerance	SMB
Carrier width	A	0.1	3.81
Carrier length	B	0.1	5.41
Carrier depth	C	0.1	2.42
Sprocket hole	d	0.05	1.5.0
13" Reel outside diameter	D	2.0	330.00
13" Reel inner diameter	D ₁	min	50.00
Feed hole diameter	D ₂	0.5	13.00
Sprocket hole position	E	0.1	1.75
Punch hole position	F	0.1	5.55
Punch hole pitch	P	0.1	8.00
Sprocket hole pitch	P ₀	0.1	4.00
Embossment center	P ₁	0.1	2.00
Overall tape thickness	T	0.1	0.30
Tape width	W	0.3	12.00
Reel width	W ₁	1.0	12.30

Note: Devices are packed in accordance with EIA standard RS-481-A and specifications listed above.

Reel packing

PACKAGE	REEL SIZE	REEL (pcs)	COMPONENT SPACING (mm)	BOX (pcs)	INNER BOX (mm)	REEL DIA, (mm)	CARTON SIZE (mm)	CARTON (pcs)	APPROX. GROSS WEIGHT (kg)
SMB	13"	3,000	4.0	6,000	190*190*41	330	365*365*360	48,000	14.0

Suggested Pad Layout

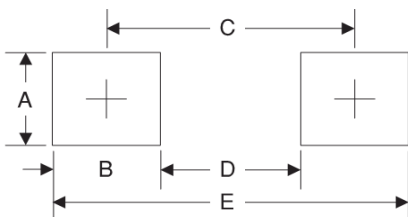

Symbol	Unit (mm)	Unit (inch)
A	2.8	0.110
B	2.4	0.094
C	4.6	0.181
D	2.2	0.086
E	7.0	0.276

Important Notice and Disclaimer

Microdiode Electronics (Jiangsu) reserves the right to make changes to this document and its products and specifications at any time without notice. Customers should obtain and confirm the latest product information and specifications before final design, purchase or use.

Microdiode Electronics (Jiangsu) makes no warranty, representation or guarantee regarding the suitability of its products for any particular purpose, nor does Microdiode Electronics (Jiangsu) assume any liability for application assistance or customer product design. Microdiode Electronics (Jiangsu) does not warrant or accept any liability with products which are purchased or used for any unintended or unauthorized application.

No license is granted by implication or otherwise under any intellectual property rights of Microdiode Electronics (Jiangsu).

Microdiode Electronics (Jiangsu) products are not authorized for use as critical components in life support devices or systems without express written approval of Microdiode Electronics (Jiangsu).