

2W05 – 2W10

2.0A BRIDGE RECTIFIER

Features

- Diffused Junction
- Low Forward Voltage Drop
- High Current Capability
- High Reliability
- High Surge Current Capability
- Ideal for Printed Circuit Boards

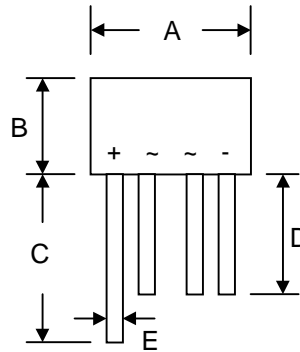

WOM		
Dim	Min	Max
A	—	9.10
B	5.00	5.50
C	30.5	—
D	25.4	—
E	0.70	0.80
G	4.60	5.60
All Dimensions in mm		

Mechanical Data

- Case: Molded Plastic
- Terminals: Plated Leads Solderable per MIL-STD-202, Method 208
- Polarity: As Marked on Body
- Weight: 1.3 grams (approx.)
- Mounting Position: Any
- Marking: Type Number
- **Lead Free: For RoHS / Lead Free Version**

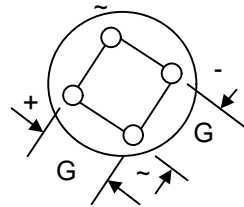

Maximum Ratings and Electrical Characteristics @ $T_A=25^\circ\text{C}$ unless otherwise specified

Single Phase, half wave, 60Hz, resistive or inductive load.
 For capacitive load, derate current by 20%.

Characteristic	Symbol	2W005	2W01	2W02	2W04	2W06	2W08	2W10	Unit
Peak Repetitive Reverse Voltage	V_{RRM}								V
Working Peak Reverse Voltage	V_{RWM}	50	100	200	400	600	800	1000	
DC Blocking Voltage	V_R								
RMS Reverse Voltage	$V_{R(RMS)}$	35	70	140	280	420	560	700	V
Average Rectified Output Current (Note 1) @ $T_A = 50^\circ\text{C}$	I_o	2.0							A
Non-Repetitive Peak Forward Surge Current 8.3ms Single half sine-wave superimposed on rated load (JEDEC Method)	I_{FSM}	50							A
Forward Voltage (per element) @ $I_F = 2.0\text{A}$	V_{FM}	1.0							V
Peak Reverse Current At Rated DC Blocking Voltage @ $T_A = 25^\circ\text{C}$ @ $T_A = 100^\circ\text{C}$	I_{RM}	2.0 500							μA
Operating Temperature Range	T_j	-55 to +150							$^\circ\text{C}$
Storage Temperature Range	T_{STG}	-55 to +150							$^\circ\text{C}$

Note: 1. Leads maintained at ambient temperature at a distance of 9.5mm from the case.

2W05 – 2W10

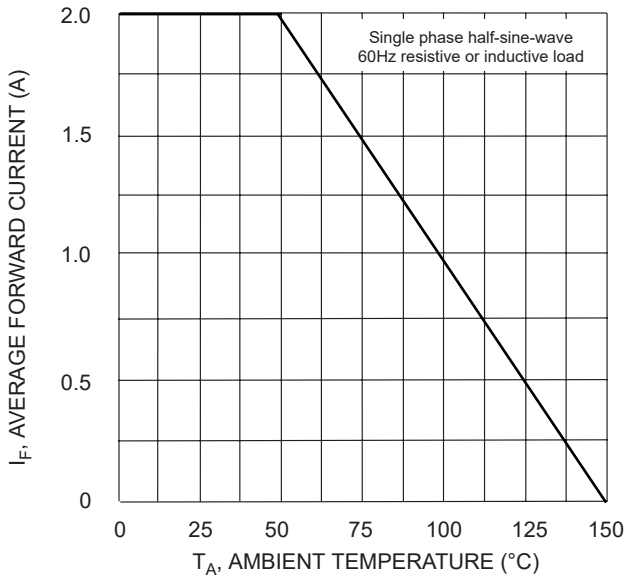

Fig. 1 Forward Current Derating Curve

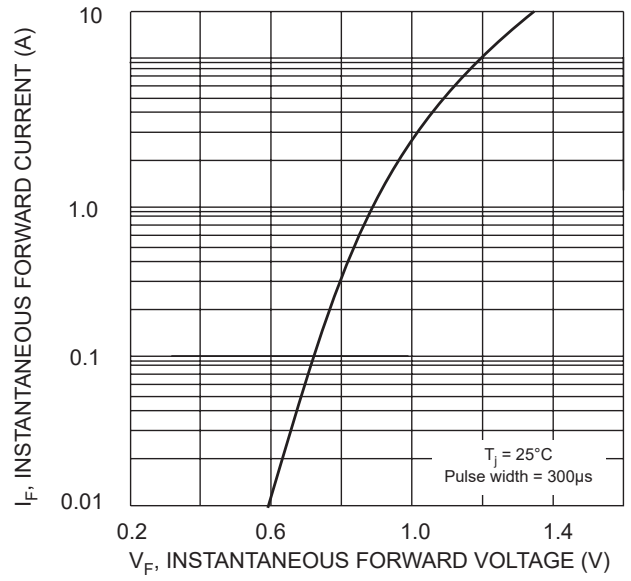

Fig. 2 Typical Forward Characteristics, per element

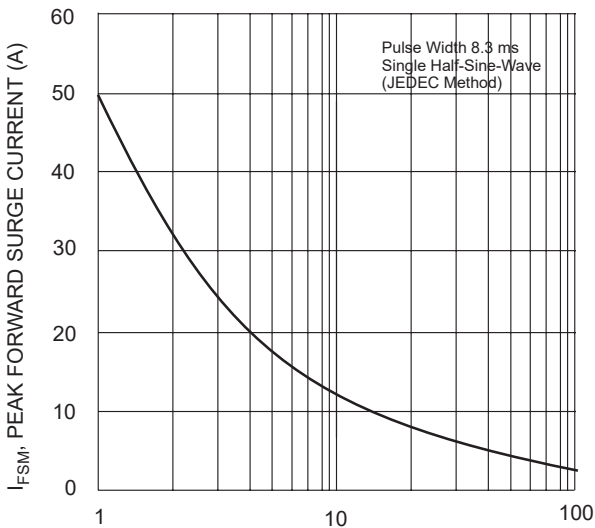

Fig. 3 Max Non-Repetitive Surge Current

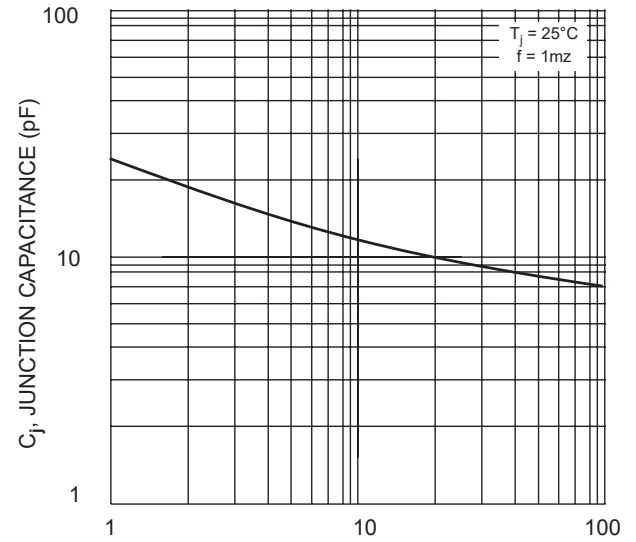

Fig. 4 Typical Junction Capacitance

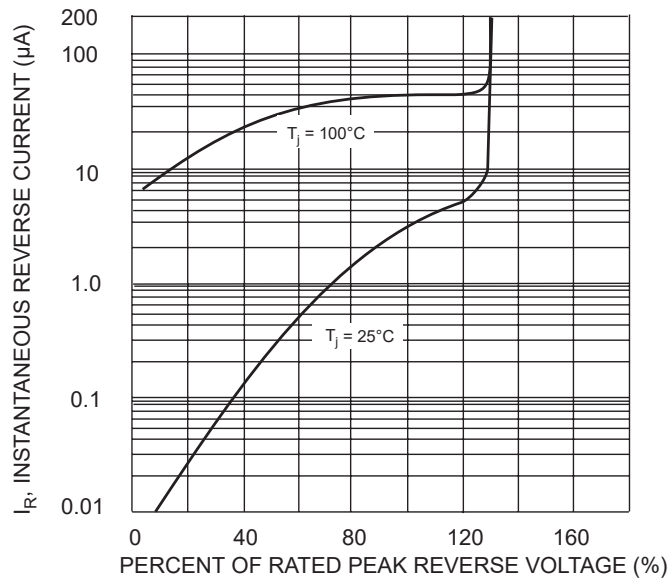

Fig. 5 Typical Reverse Characteristics