

Chip Phototransistor with spherical top view Lens

LKPT30102B-A01(XY)

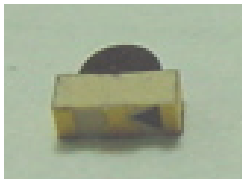

Preliminary

This is a preliminary specification intended for design purposes and subject to change without prior notice.

Features

- Fast response time
- High photo sensitivity
- Small junction capacitance
- Package in 8mm tape on “7” diameter reels.
- Pb free
- The product itself will remain within RoHS compliant version.
- Compliance with EU REACH
- Compliance Halogen Free .(Br <900 ppm ,Cl <900 ppm , Br+Cl < 1500 ppm).

Descriptions

- LKPT30102B-A01 is a phototransistor in miniature SMD package which is molded in a Black epoxy with spherical top view lens.
- The device is Spectrally matched to infrared emitting diode.

Applications

- Miniature switch
- Counters and sorter
- Position sensor
- Infrared applied system

Device Selection Guide

Part Category	Chip Material	Resin Color
PT	Silicon	Black

Absolute Maximum Ratings (Ta=25°C)

Parameter	Symbol	Rating	Units
Collector-Emitter Voltage	V_{CEO}	30	V
Emitter-Collector-Voltage	V_{ECO}	5	V
Collector Current	I_C	50	mA
Operating Temperature	T_{opr}	-25 ~ +85	°C
Storage Temperature	T_{stg}	-40 ~ +85	°C
Soldering Temperature	T_{sol}	260	°C
Power Dissipation at (or below) 25°C Free Air Temperature	P_c	75	mW

Notes: *1:Soldering time \leq 5 seconds.

Electro-Optical Characteristics (Ta=25°C)

Parameter	Symbol	Condition	Min	Typ	Max	Unit
Rang Of Spectral Bandwidth	$\lambda_{0.5}$	---	730	---	1100	nm
Wavelength Of Peak Sensitivity	λ_P	---	---	940	---	nm
Collector-Emitter BreakdownVoltage	BV_{CEO}	$I_C=100\mu A$ $E_e=0mW/cm^2$	30	---	---	V
Emitter-Collector BreakdownVoltage	BV_{ECO}	$I_E=100\mu A$ $E_e=0mW/cm^2$	5	---	---	V
Collector-Emitter SaturationVoltage	$V_{CE(sat)}$	$I_C=2mA$ $E_e=1m W/cm^2$	---	---	0.4	V
Collector Dark Current	I_{CEO}	$V_{CE}=20V$ $E_e=0mW/cm^2$	---	---	100	nA
On State Collector Current	$I_{C(ON)}$	$V_{CE}=5V$ $E_e=1mW /cm^2$	0.4	---	---	mA

Typical Electro-Optical Characteristics Curves

Fig.1 Spectral Sensitivity

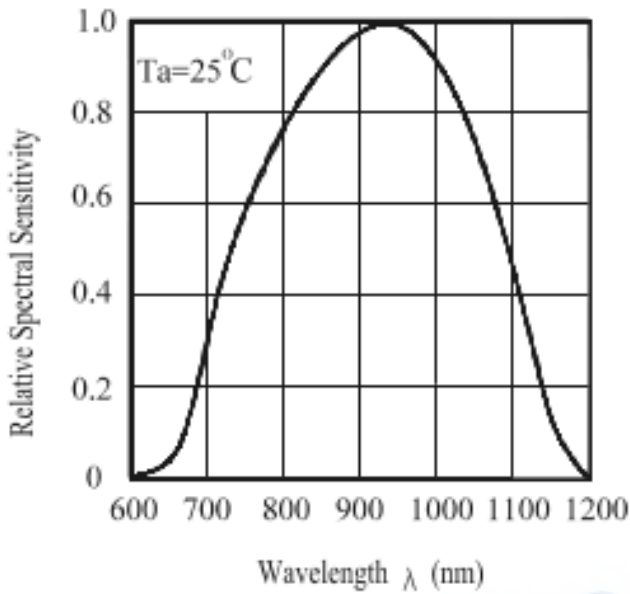

Fig.4 Collector Current vs. Irradiance

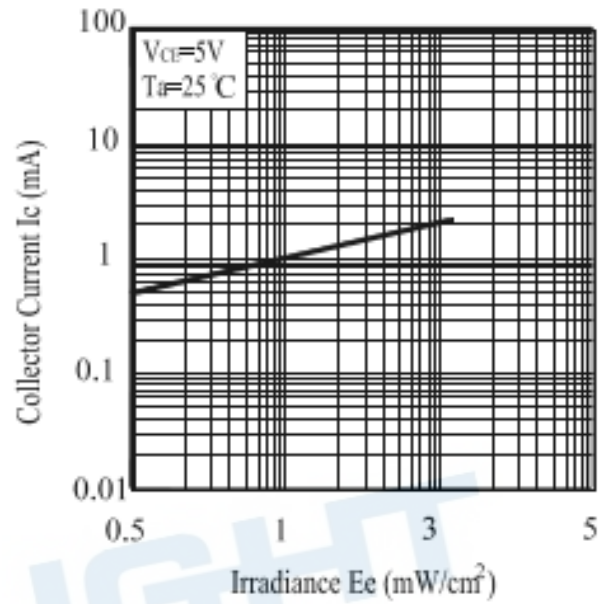
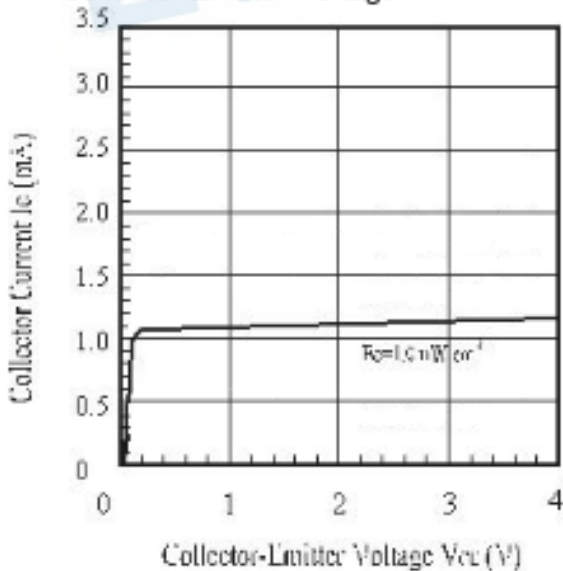

Fig.6 Collector Current vs. Collector-Emitter Voltage



Precautions For Use

1. Over-current-proof

Customer must apply resistors for protection, otherwise slight voltage shift will cause big current change (Burn out will happen).

2. Storage

2.1 Do not open moisture proof bag before the products are ready to use.

2.2 Before opening the package, the Phototransistor should be kept at 10°C~30°C and 90%RH or less.

2.3 The Phototransistor suggested be used within one year.

2.4 After opening the package, the devices must be stored at 10°C~30°C and $\leq 60\%RH$, and used within 168 hours (floor life). If unused Phototransistor remain, it should be stored in moisture proof packages.

2.5 If the moisture absorbent material (desiccant material) has faded or unopened bag has exceeded the shelf life or devices (out of bag) have exceeded the floor life, baking treatment is required.

2.6 If baking is required, refer to IPC/JEDEC J-STD-033 for bake procedure or recommend the following conditions:

96 hours at 60°C $\pm 5^\circ\text{C}$ and $< 5\% RH$ (reeled/tubed/loose units)

3. Soldering Condition

3.1 Pb-free solder temperature profile

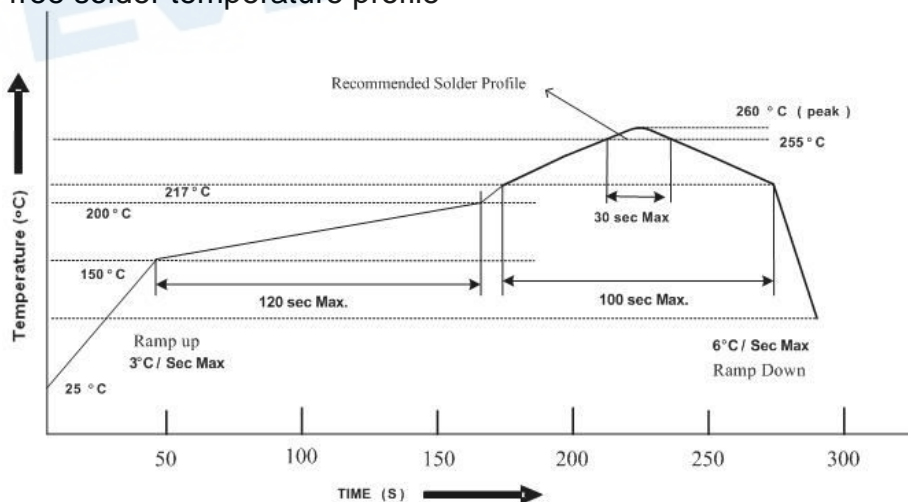

3.2 Reflow soldering should not be done more than two times.

3.3 When soldering, do not put stress on the Phototransistor during heating.

3.4 After soldering, do not warp the circuit board.

4. Soldering Iron

Each terminal is to go to the tip of soldering iron temperature less than 350°C for 3 seconds within once in less than the soldering iron capacity 25W. Leave two seconds and more intervals, and do soldering of each terminal. Be careful because the damage of the product is often started at the time of the hand solder.

5. Repairing

Repair should not be done after the Phototransistor have been soldered. When repairing is unavoidable, a double-head soldering iron should be used (as below figure). It should be confirmed beforehand whether the characteristics of the Phototransistor will or will not be damaged by repairing.

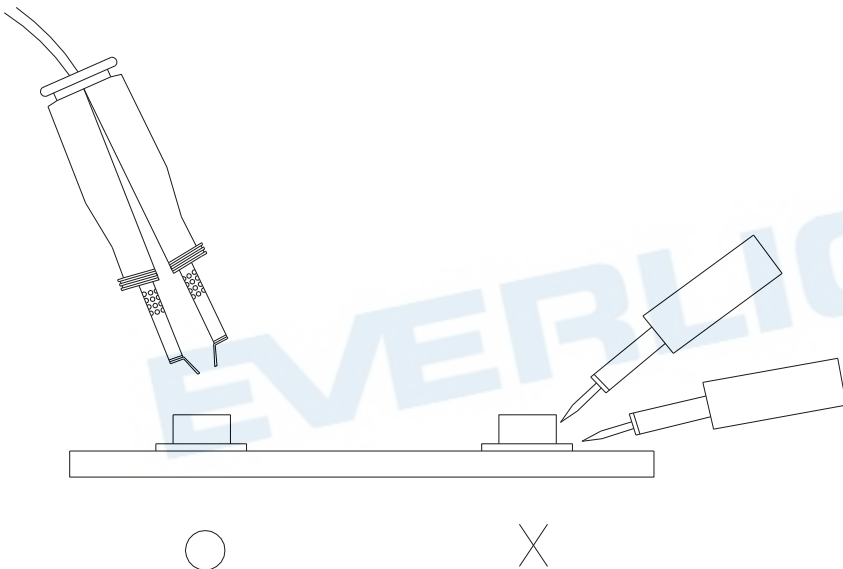

Package Dimensions

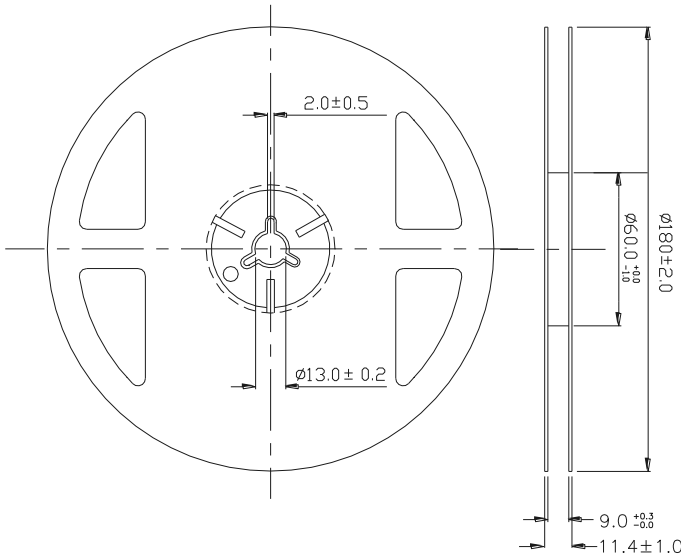

Note: The tolerances unless mentioned are ± 0.1 mm, Unit: mm





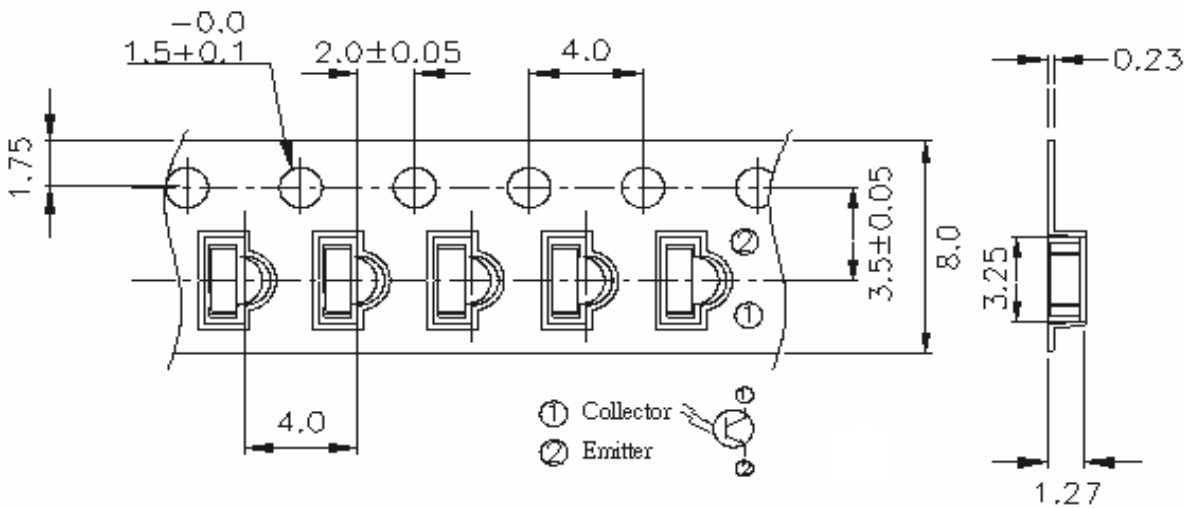

Carrier Taping Dimensions: (Quantity: 2000PCS/Reel)

Feeding Direction



Note: The tolerances unless mentioned are ± 0.1 mm, Unit: mm

Label Form Specification

RoHS		EVERLIGHT	5
CPN: XXXXXXXXXXXXXXXXXXXX			
			
XXXXXXXXXX-XXXXXXXXXX-XXXXXXXXXX-XXXXXXXXXX-XXXXXX			
P/N: XXXXXXXXXXXX			
			
XXXXXXXXXX-XXXXXXXXXX-XXXXXXXXXX-XXXXXXXXXX-XXXXXX			
LOT NO: Y150716XXX-XXXXXXXXXX-XXXXXXXXXX			
			
QTY: 0123456789 HUE: XXXXXXXXXXXX			
			
CAT: XXXXXXXXXXXX REF: XXXXXXXXXXXX			
			
REFERENCE: BTPYYMDDXXXXX			
			
MSL-X MADE IN XXXXXX			

CPN: Customer's Production Number

P/N : Production Number

LOT No: Lot Number

QTY: Packing Quantity

HUE: Peak Wavelength

CAT: Ranks

REF: Reference

MSL-X: MSL Level

Made In: Manufacture place

DISCLAIMER

1. EVERLIGHT reserves the right(s) on the adjustment of product material mix for the specification.
2. The product meets EVERLIGHT published specification for a period of twelve (12) months from date of shipment.
3. The graphs shown in this datasheet are representing typical data only and do not show guaranteed values.
4. When using this product, please observe the absolute maximum ratings and the instructions for using outlined in these specification sheets. EVERLIGHT assumes no responsibility for any damage resulting from the use of the product which does not comply with the absolute maximum ratings and the instructions included in these specification sheets.
5. These specification sheets include materials protected under copyright of EVERLIGHT. Reproduction in any form is prohibited without obtaining EVERLIGHT's prior consent.
6. This product is not intended to be used for military, aircraft, automotive, medical, life sustaining or life saving applications or any other application which can result in human injury or death. Please contact authorized Everlight sales agent for special application request.

EVERLIGHT ELECTRONICS CO., LTD.

Office: No. 6-8, Zhonghua Rd., Shulin Dist.,

New Taipei City 23860, Taiwan

Tel: 886-2-2685-6688

Fax: 886-2685-2699 · 6897

<http://www.everlight.com>