

低成本 单声道 1W 音频功率放大器

产品概述

LN4890 是差分输入音频功率放大电路，适用于移动电话和其他内置扬声器的便携式音频设备。它能够为 8Ω 负载提供 1W 功率的稳定输出，5V 电源供电的条件下其总谐波失真和噪声不超过 1%。LN4890 采用桥接负载结构在提供高品质音频功率放大的同时，大大减少了外部元件数，无需外接输出耦合电容和自举电容。

LN4890 内置待机电路，当 SHUTDOWN 管脚接低电平时，整个电路工作在待机模式，待机电流不超过 100nA。

LN4890 内置了杂音消除电路，可以消除芯片启动和关断过程中的咔嚓声或噼噝声。还可以通过外接电阻来调节增益。

关键指标

- PSRR @ $f_{IN}=217\text{HZ}$, VDD=5V 62dB(typ.)
- 功率输出@VDD=5V & 1% THD 1W(typ.)
- 功率输出@VDD=3V & 1% THD 400mW(typ.)
- 关断电流 0.1uA(typ.)

典型应用电路图

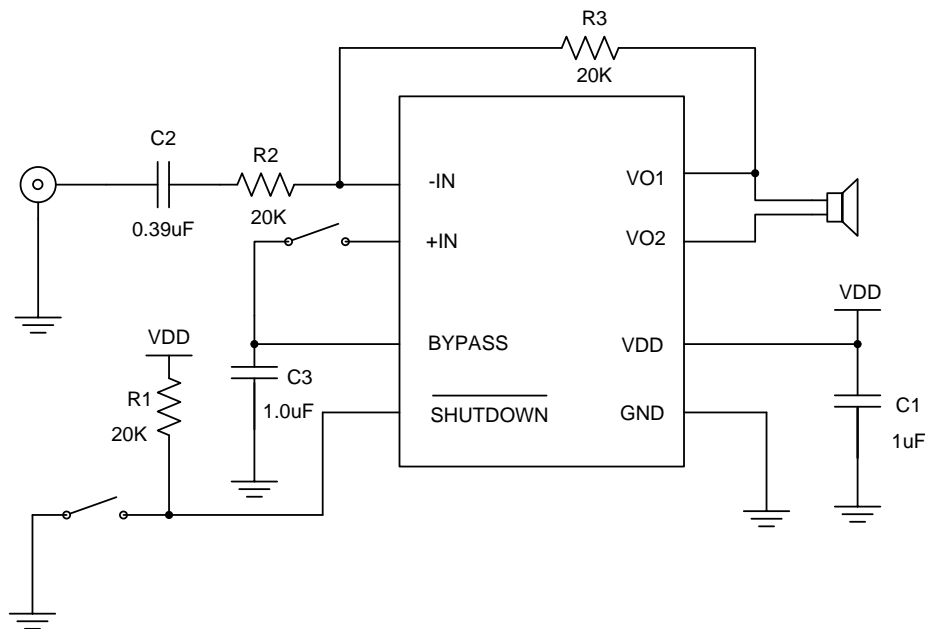

用途

- 移动电话
- PDA
- 便携电子设备

产品特点

- 工作电压范围宽：2.2—5.0V
- 无需输出耦合电容、缓冲网络或自举电容
- 热保护功能
- 内部增益固定，外部增益可调
- 超小型封装
- 100nA 的低功耗关断模式
- BTL 输出可以驱动容性负载
- 上电/断电时无咔嚓声或噼噝声

封装

- MSOP8
- SOP8

■ 订购信息

LN4890①②③-④

项目	符号	描述
①②		封装类型
	MM	MSOP8
	SR	SOP8
③	A	输入大于 5.2V 时自动关闭
	C	没有高压自动关闭功能
	D	没有高压自动关闭功能，且高温保护情况下增益自动降低至 1 倍
	E	没有高压自动关闭功能，且高温保护情况下增益自动降低至 1 倍，启动时间为 D 版本的 1/4。
④	G	绿料

■ 引脚配置

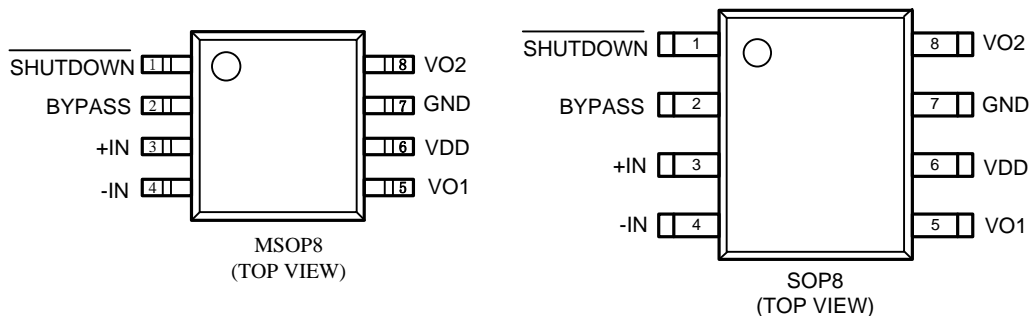

■ 引脚功能描述

引脚号	引脚名称	功能描述
1	SHUTDOWN	芯片使能端（低有效）
2	BYPASS	旁路电容输入端
3	+IN	正输入端（差分+）
4	-IN	负输入端（差分-）
5	VO1	负输出端（差分-）
6	VDD	电源输入端
7	GND	接地端
8	VO2	正输出端（差分+）

■ 打印信息

- MSOP8、SOP8

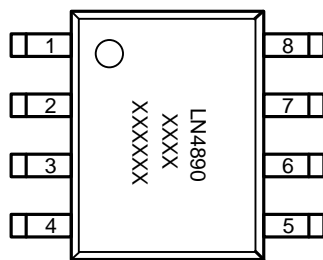

SOP8
(TOP VIEW)

第二行 XXXX: 晶圆版本号;

第三行 XXXXXX: 封装批号。

■ 绝对最大额定值

项目	符号	值	单位
工作电压	VDD	-0.3—5.2	V
输入电压	-IN	-0.3—VDD+0.3	V
工作温度	Topr	-40—85	°C
贮存温度	Tstg	-65—150	°C
ESD 参数	-	2000	V

注: LN4890*A 版本的工作电压最大值是 5.2V, 其他版本稍有差异

■ 功能框图

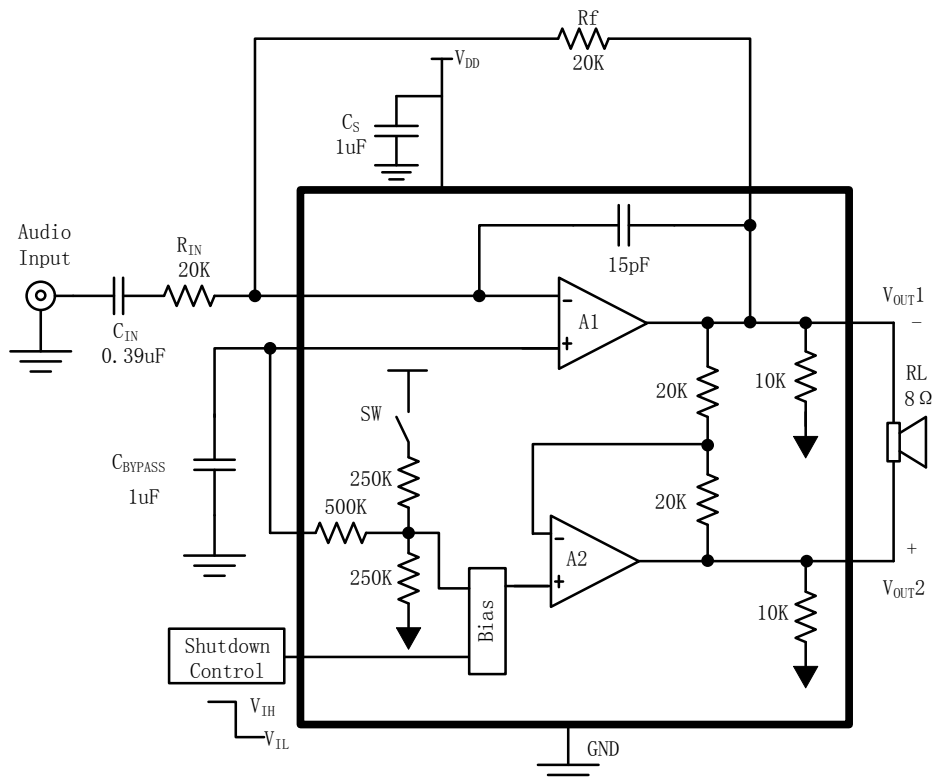

■ 电学特性参数
VDD=5V

 (除非特别说明, $T_a=25^{\circ}\text{C}$)

符号	参数	测试条件	最小	典型	最大	单位
I_{DD}	静态电流	-IN = 0V, $I_o = 0\text{A}$, No Load	-	4	8	mA
		-IN = 0V, $I_o = 0\text{A}$, 8 Ω Load	-	5	10	mA
I_{SD}	关断电流	$V_{SHUTDOWN} = 0\text{V}$	-	0.1	2	μA
V_{SDIH}	关断电压 输入高电平	-	1.5	-	-	V
V_{SDIL}	关断电压 输入低电平	-	-	-	0.4	V
V_{OS}	输出失调电压	-	-	7	50	mV
$R_{OUT-GND}$	输出电阻	-	7.0	8.5	9.7	k Ω
P_O	输出功率	THD = 2% (max); $f = 1\text{ kHz}$ 8 Ω Load	0.8	1.0	-	W
T_{WU}	启动时间	-	-	170	220	ms
T_{SD}	热关断温度	-	150	170	190	$^{\circ}\text{C}$
THD+N	总谐波失真 +噪声	$P_o = 0.4\text{ Wrms}$; $f = 1\text{ kHz}$	-	0.1	-	%
PSRR	电源抑制比	$V_{ripple} = 200\text{mV sine p-p}$ $f=217\text{Hz}$	55	62	-	dB
		$V_{ripple} = 200\text{mV sine p-p}$ $f=1\text{kHz}$		66		
T_{SDT}	关断时间	8 Ω Load	-	1.0	-	ms

VDD=3V

 (除非特别说明, $T_a=25^{\circ}\text{C}$)

符号	参数	测试条件	最小	典型	最大	单位
I_{DD}	静态电流	-IN = 0V, $I_o = 0A$, No Load	-	3.5	7	mA
		-IN = 0V, $I_o = 0A$, 8Ω Load	-	4.5	9	mA
I_{SD}	关断电流	$V_{SHUTDOWN} = 0V$	-	0.1	2	μA
V_{SDIH}	关断电压 输入高电平	-	1.2	-	-	V
V_{SDIL}	关断电压 输入低电平	-	-	-	0.4	V
V_{OS}	输出失调电压	-	-	7	50	mV
$R_{OUT-GND}$	输出电阻	-	7.0	8.5	9.7	kΩ
P_o	输出功率	THD = 2% (max); $f = 1\text{ kHz}$ 8Ω Load	0.28	0.31	-	W
T_{WU}	启动时间	-	-	170	220	ms
T_{SD}	热关断温度	-	150	170	190	°C
THD+N	总谐波失真 +噪声	$P_o = 0.4\text{ Wrms}$; $f = 1\text{ kHz}$	-	0.1	-	%
PSRR	电源抑制比	$V_{ripple} = 200\text{mV}_{\text{sine p-p}}$ $f=217\text{Hz}$	45	56	-	dB
		$V_{ripple} = 200\text{mV}_{\text{sine p-p}}$ $f=1\text{kHz}$		62		

VDD=2.6V

 (除非特别说明, $T_a=25^{\circ}\text{C}$)

符号	参数	测试条件	最小	典型	最大	单位	
I_{DD}	静态电流	-IN = 0V, $I_o = 0A$, No Load	-	2.6	5.5	mA	
I_{SD}	关断电流	$V_{SHUTDOWN} = 0V$	-	0.1	2	μA	
P_o	输出功率	THD = 1% (max); $f = 1\text{ kHz}$	-	8Ω Load	0.2	-	W
		4Ω Load		0.22			
THD+N	总谐波失真 +噪声	$P_o = 0.1\text{ Wrms}$; $f = 1\text{ kHz}$	-	0.08	-	%	
PSRR	电源抑制比	$V_{ripple} = 200\text{mV}_{\text{sine p-p}}$ $f=217\text{Hz}$	-	44	-	dB	
		$V_{ripple} = 200\text{mV}_{\text{sine p-p}}$ $f=1\text{kHz}$		44			

■ 特性曲线

THD+N vs Frequency
at $V_{DD} = 5V$, $8\Omega R_L$, and $PWR = 250mW$, $A_V = 2$

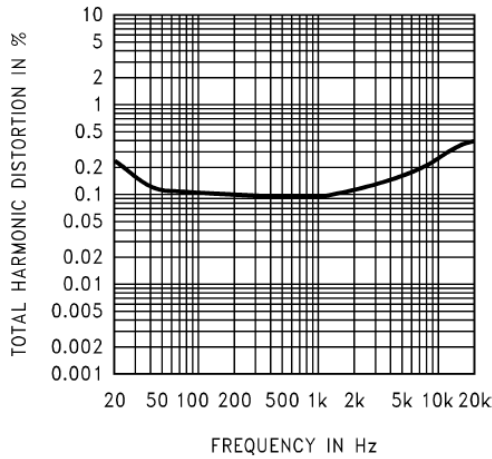

THD+N vs Frequency
at $V_{DD} = 3.3V$, $8\Omega R_L$, and $PWR = 150mW$, $A_V = 2$

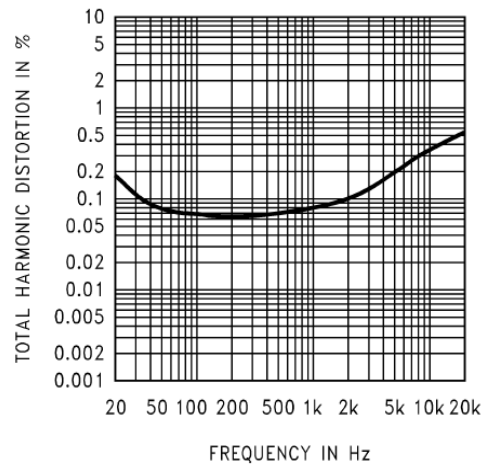

THD+N vs Frequency
at $V_{DD} = 3V$, $R_L = 8\Omega$, $PWR = 250mW$, $A_V = 2$

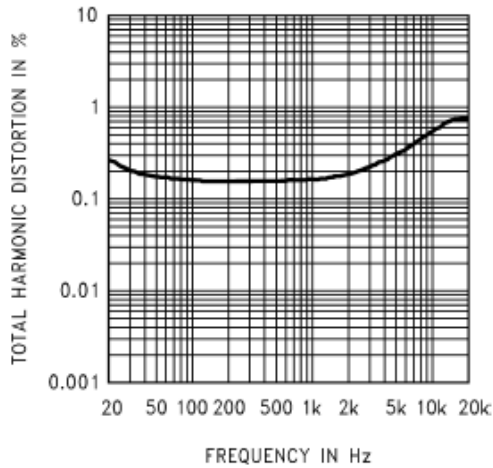

THD+N vs Frequency
@ $V_{DD} = 2.6V$, $R_L = 8\Omega$, $PWR = 100mW$, $A_V = 2$

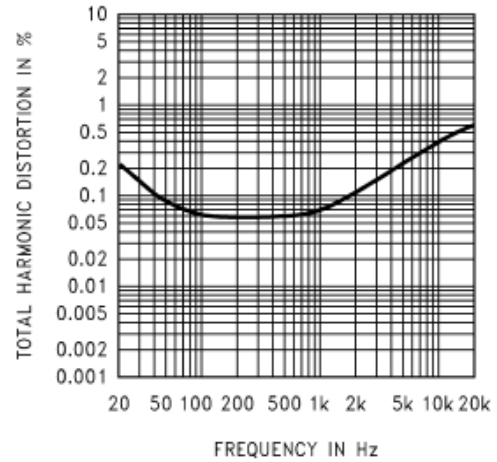

THD+N vs Frequency
@ $V_{DD} = 2.6V$, $R_L = 4\Omega$, $PWR = 100mW$, $A_V = 2$

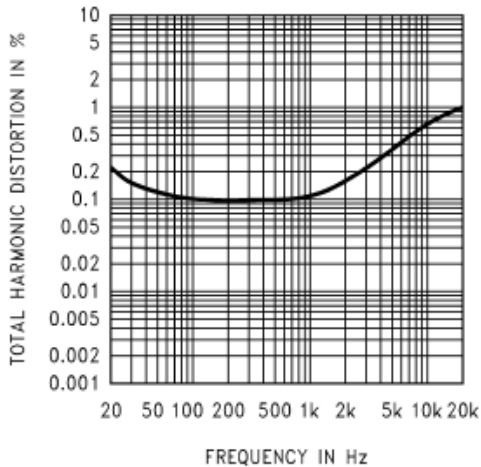

THD+N vs Power Out
@ $V_{DD} = 5V$, $R_L = 8\Omega$, $1kHz$, $A_V = 2$

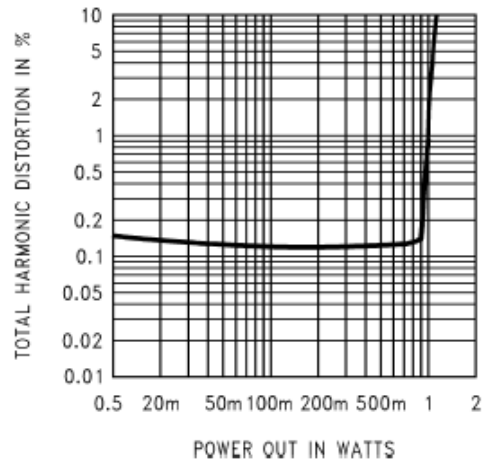

THD+N vs Power Out

@ $V_{DD} = 3V, R_L = 8\Omega, 1kHz, A_V = 2$

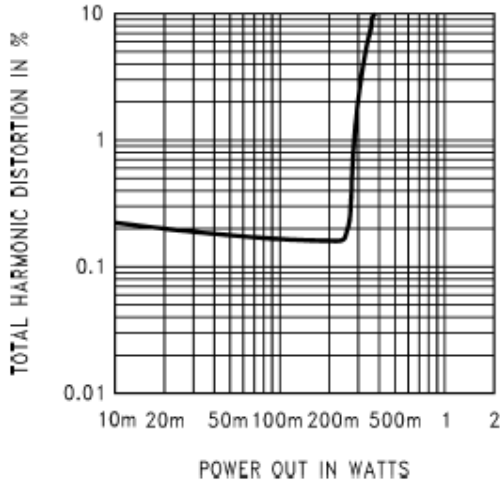

THD+N vs Power Out

@ $V_{DD} = 2.6V, R_L = 8\Omega, 1kHz, A_V = 2$

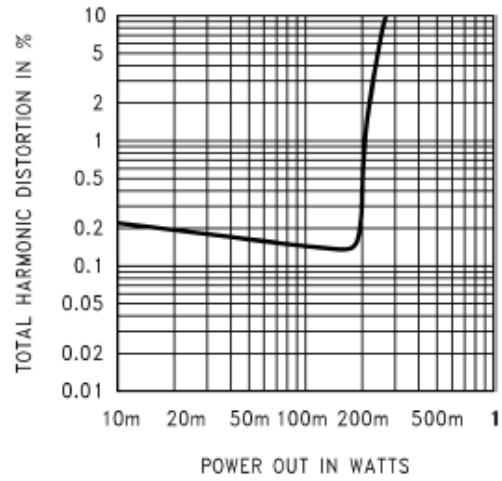

THD+N vs Power Out

@ $V_{DD} = 2.6V, R_L = 4\Omega, 1kHz, A_V = 2$

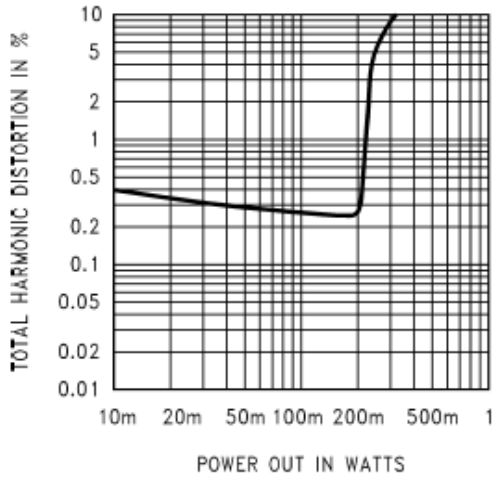

Power Supply Rejection Ratio (PSRR) @ $A_V = 2$

$V_{DD} = 5V, V_{ripple} = 200mvp-p$
 $R_L = 8\Omega, R_{IN} = 10\Omega$

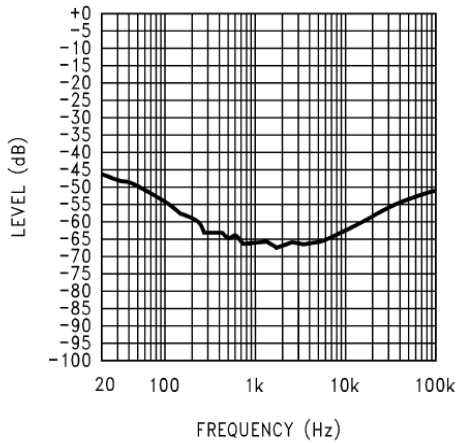

Power Supply Rejection Ratio (PSRR) @ $A_V = 2$

$V_{DD} = 5V, V_{ripple} = 200mvp-p$
 $R_L = 8\Omega, R_{IN} = Float$

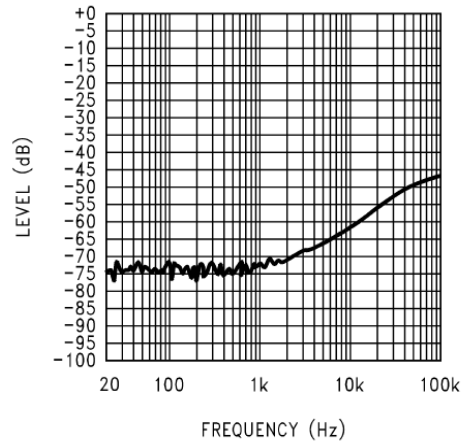

Power Supply Rejection Ratio (PSRR) @ $A_V = 4$

$V_{DD} = 5V$, $V_{ripple} = 200mvp-p$
 $R_L = 8\Omega$, $R_{IN} = 10\Omega$

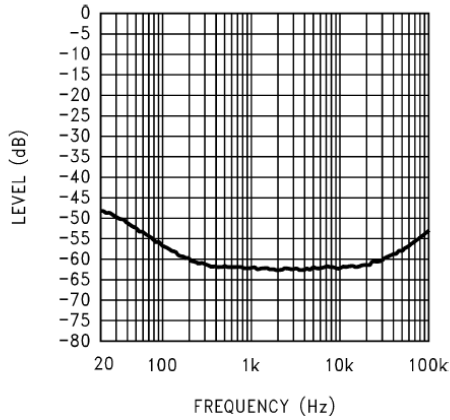

Power Supply Rejection Ratio (PSRR) @ $A_V = 4$

$V_{DD} = 5V$, $V_{ripple} = 200mvp-p$
 $R_L = 8\Omega$, $R_{IN} = Float$

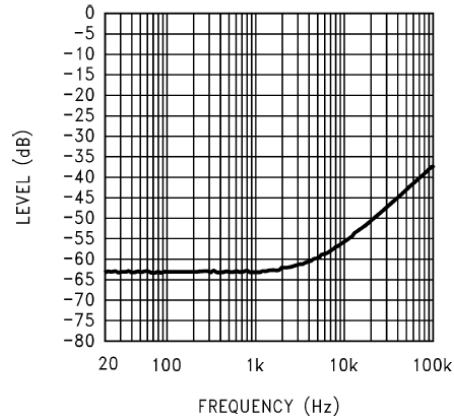

Power Supply Rejection Ratio (PSRR) @ $A_V = 2$

$V_{DD} = 3V$, $V_{ripple} = 200mvp-p$,
 $R_L = 8\Omega$, $R_{IN} = 10\Omega$

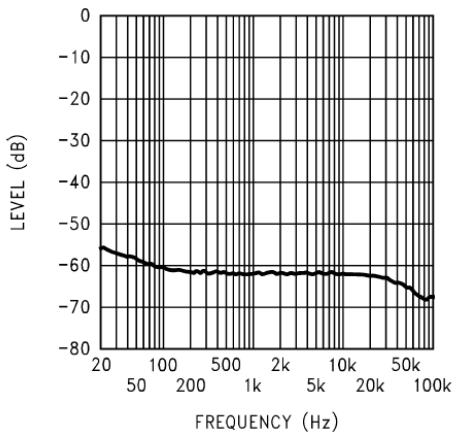

Power Supply Rejection Ratio (PSRR) @ $A_V = 2$

$V_{DD} = 3V$, $V_{ripple} = 200mvp-p$,
 $R_L = 8\Omega$, $R_{IN} = Float$

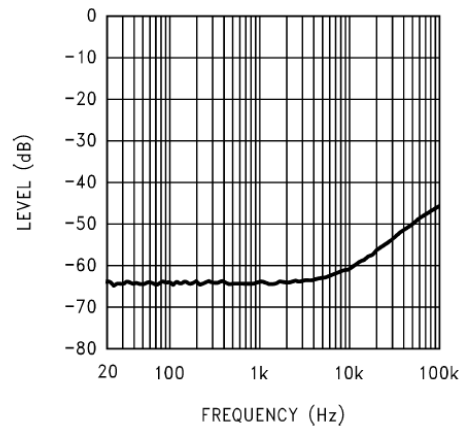

Power Supply Rejection Ratio (PSRR) @ $A_V = 4$

$V_{DD} = 3V$, $V_{ripple} = 200mvp-p$,
 $R_L = 8\Omega$, $R_{IN} = 10\Omega$

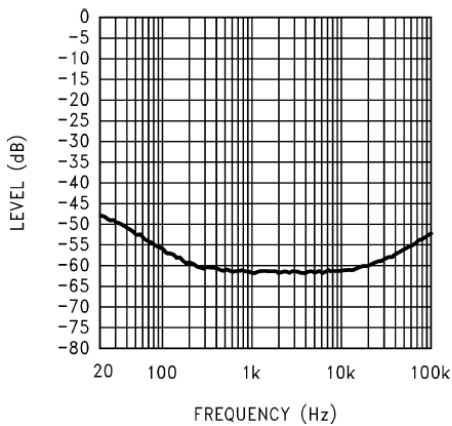

Power Supply Rejection Ratio (PSRR) @ $A_V = 4$

$V_{DD} = 3V$, $V_{ripple} = 200mvp-p$,
 $R_L = 8\Omega$, $R_{IN} = Float$

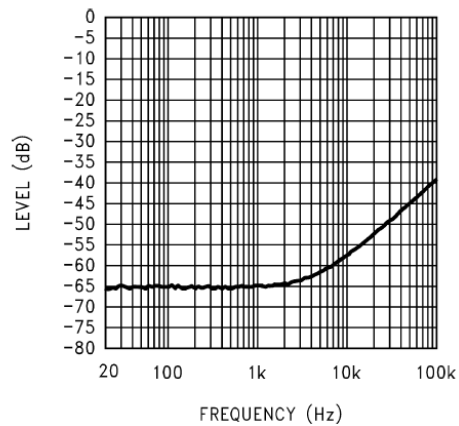

Power Supply Rejection Ratio (PSRR) @ $A_V = 2$

$V_{DD} = 3.3V$, $V_{ripple} = 200mvp-p$,
 $R_L = 8\Omega$, $R_{IN} = 10\Omega$

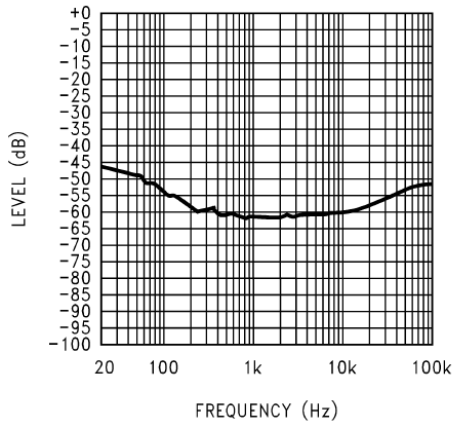

Power Supply Rejection Ratio (PSRR) @ $A_V = 2$

$V_{DD} = 2.6V$, $V_{ripple} = 200mvp-p$,
 $R_L = 8\Omega$, $R_{IN} = 10\Omega$

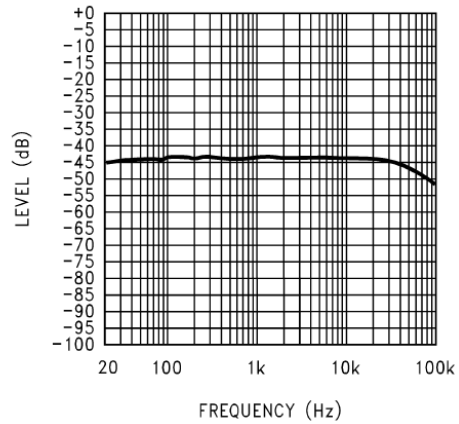

PSRR vs DC Output Voltage

$V_{DD} = 5V$, $A_V = 10$

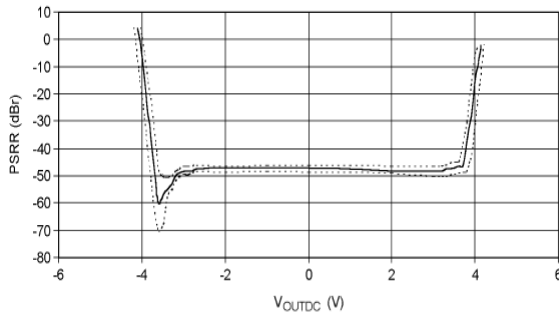

PSRR vs DC Output Voltage

$V_{DD} = 3V$, $A_V = 2$

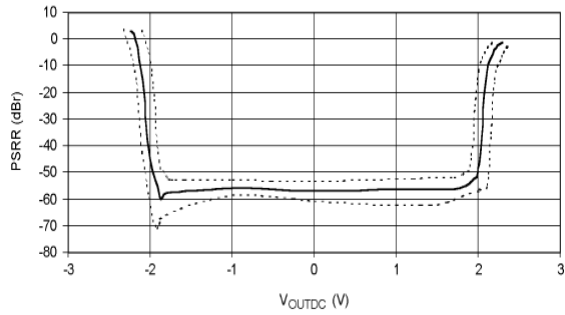

PSRR vs DC Output Voltage

$V_{DD} = 3V$, $A_V = 4$

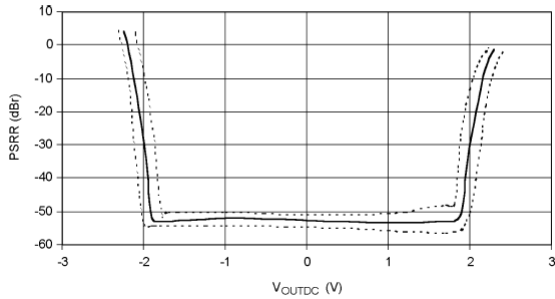

PSRR vs DC Output Voltage

$V_{DD} = 3V$, $A_V = 10$

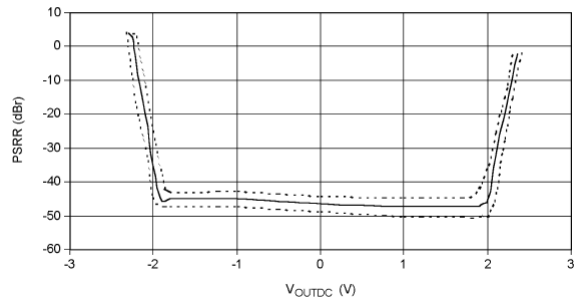

PSRR Distribution $V_{DD} = 5V$

217Hz, 200mvp-p,
-30, +25, and +80°C

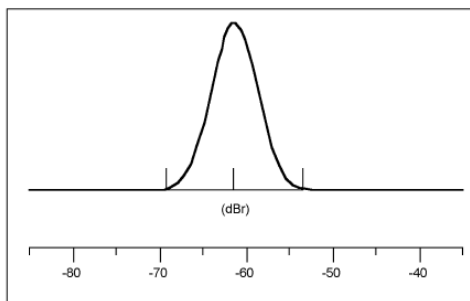

PSRR Distribution $V_{DD} = 3V$

217Hz, 200mvp-p,
-30, +25, and +80°C

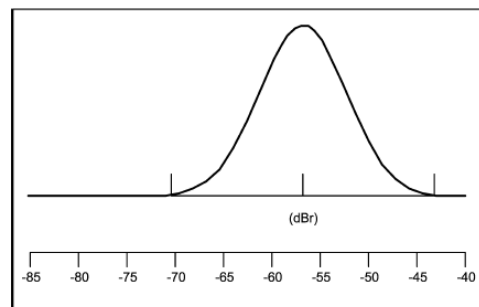

Power Supply Rejection Ratio vs Bypass Capacitor Size

$V_{DD} = 5V$, Input Grounded = 10Ω , Output Load = 8Ω

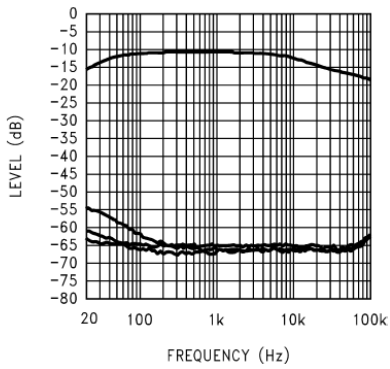

Top Trace = No Cap, Next Trace Down = $1\mu f$
Next Trace Down = $2\mu f$, Bottom Trace = $4.7\mu f$

Power Supply Rejection Ratio vs Bypass Capacitor Size

$V_{DD} = 3V$, Input Grounded = 10Ω , Output Load = 8Ω

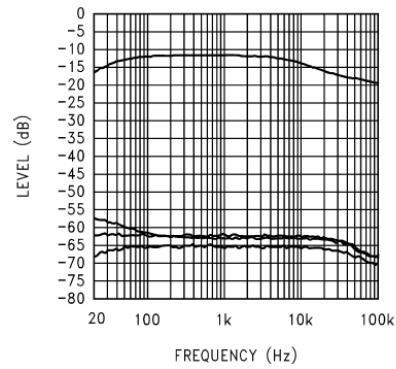

Top Trace = No Cap, Next Trace Down = $1\mu f$
Next Trace Down = $2\mu f$, Bottom Trace = $4.7\mu f$

Output Offset Voltage

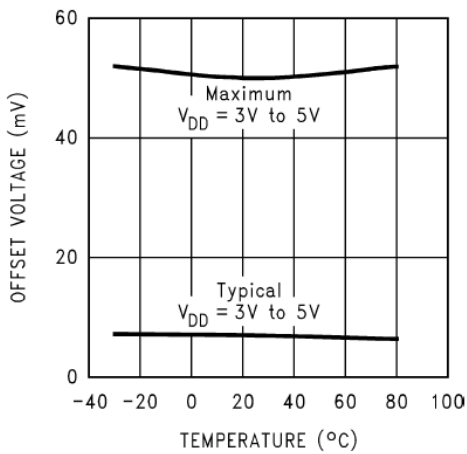

Supply Current vs Shutdown Voltage

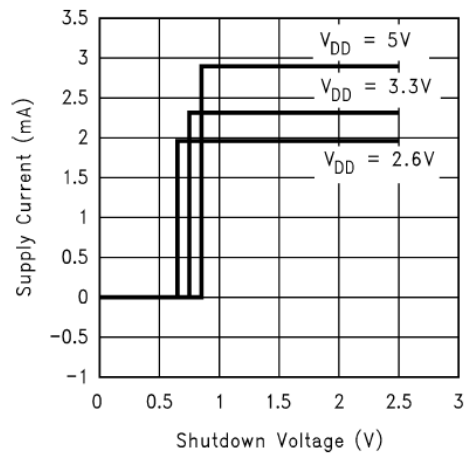

Shutdown Hysteresis Voltage
 $V_{DD} = 5V$

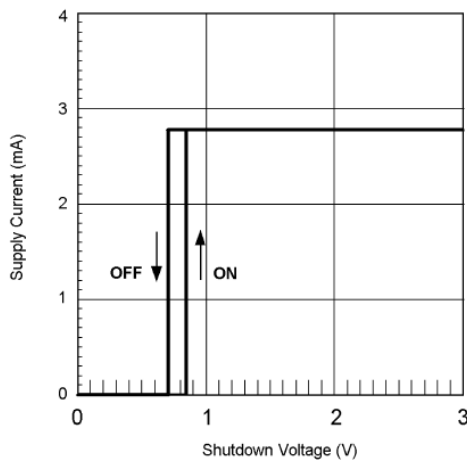

Shutdown Hysteresis Voltage
 $V_{DD} = 3V$

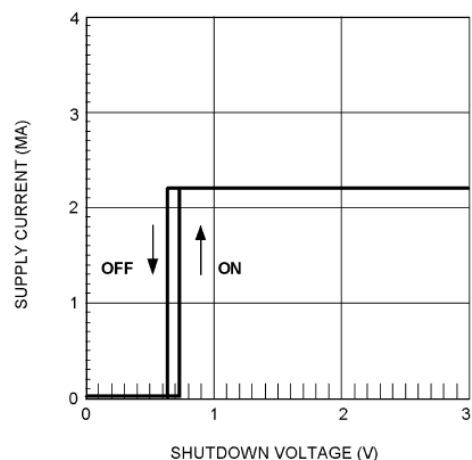

Open Loop Frequency Response
 $V_{DD} = 5V$, No Load

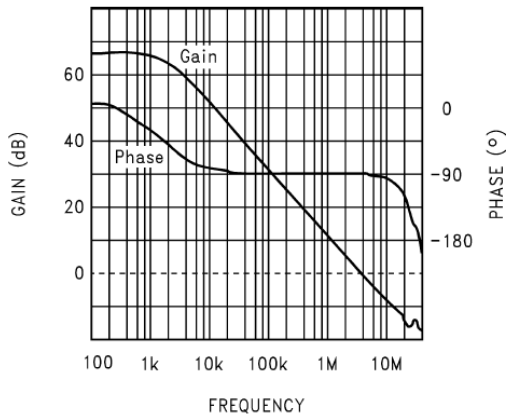

Open Loop Frequency Response
 $V_{DD} = 3V$, No Load

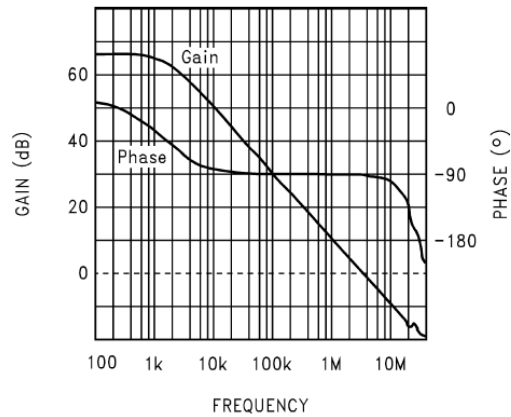

Gain / Phase Response, $A_V = 2$
 $V_{DD} = 5V$, 8Ω Load, $C_{LOAD} = 500pF$

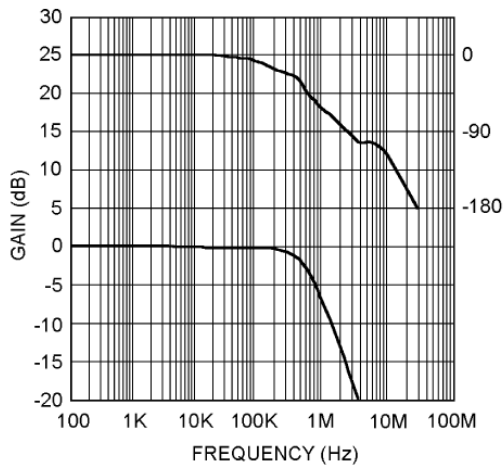

Gain / Phase Response, $A_V = 4$
 $V_{DD} = 5V$, 8Ω Load, $C_{LOAD} = 500pF$

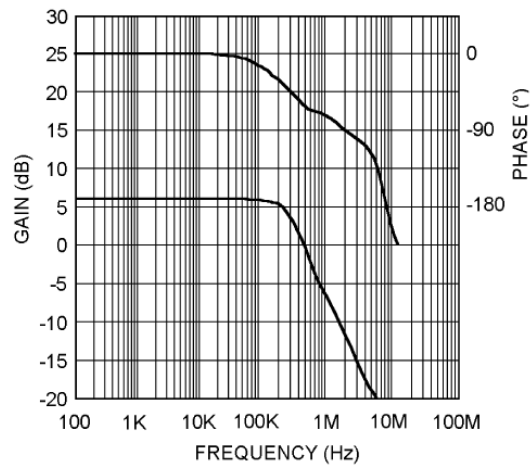

Phase Margin vs C_{LOAD} , $A_V = 2$
 $V_{DD} = 5V$, 8Ω Load
Capacitance to gnd on each output

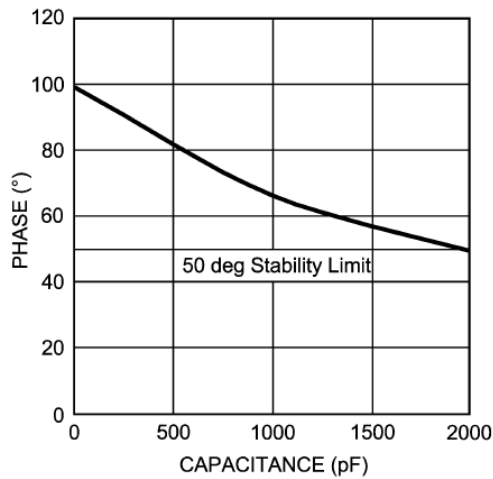

Phase Margin vs C_{LOAD} , $A_V = 4$
 $V_{DD} = 5V$, 8Ω Load
Capacitance to gnd on each output

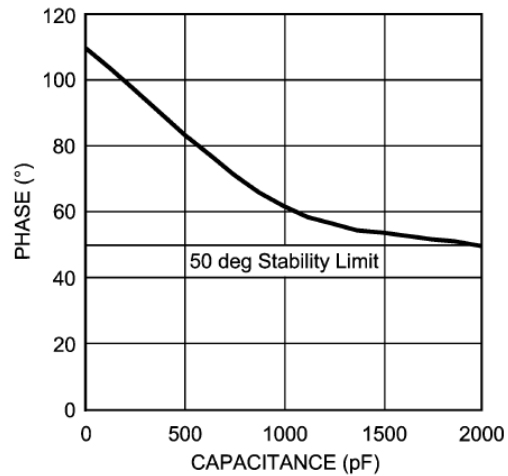

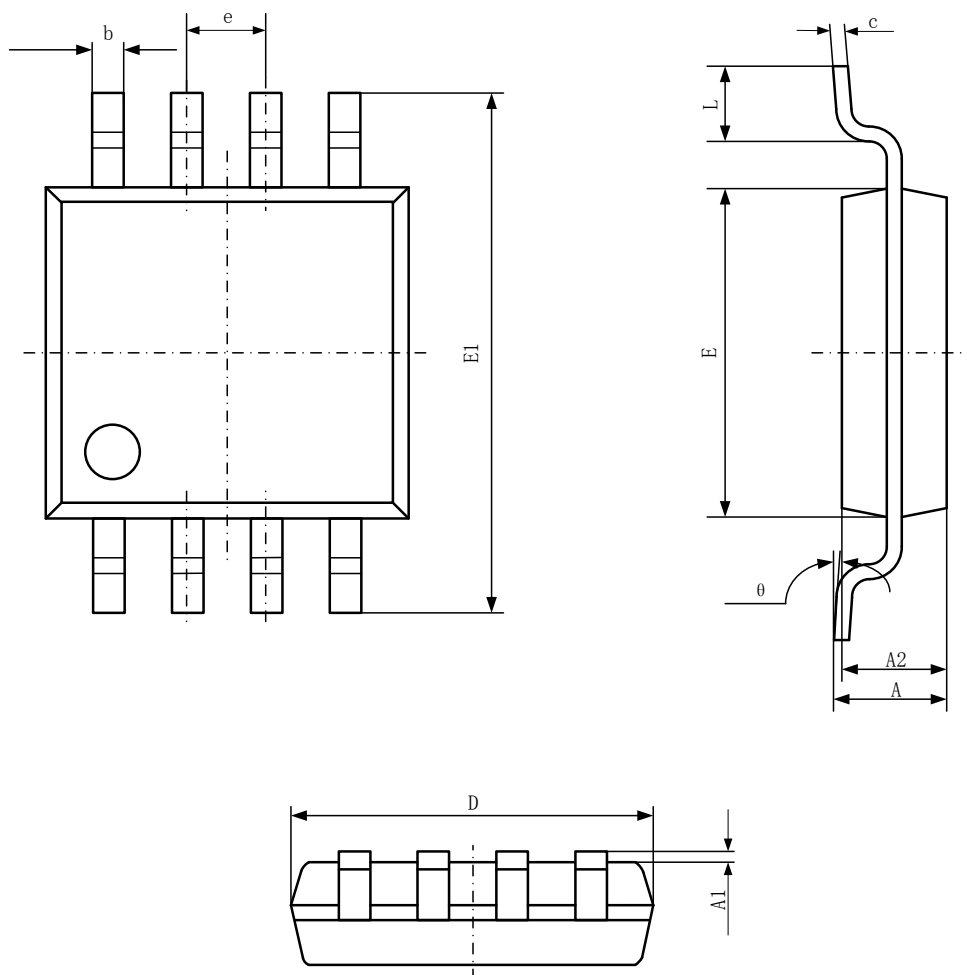
■ 封装信息
● MSOP8

Symbol	Dimensions In Millimeters		Dimensions In Inches	
	Min	Max	Min	Max
A	0.820	1.100	0.032	0.043
A1	0.020	0.150	0.001	0.006
A2	0.750	0.950	0.030	0.037
b	0.250	0.380	0.010	0.015
c	0.090	0.230	0.004	0.009
D	2.900	3.100	0.114	0.122
e	0.650(BSC)		0.026(BSC)	
E	2.900	3.100	0.144	0.122
E1	4.750	5.050	0.187	0.199
L	0.400	0.800	0.016	0.031
θ	0°	6°	0°	6°

● SOP8

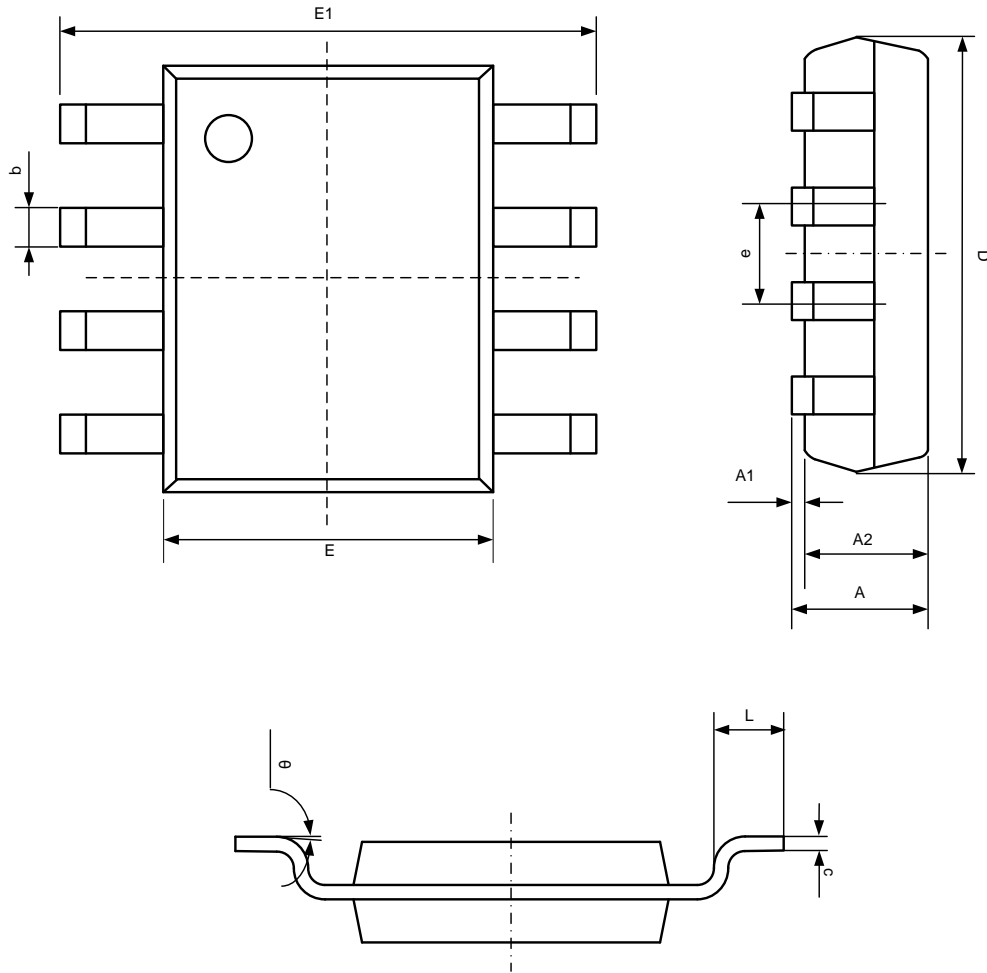

Symbol	Dimensions In Millimeters		Dimensions In Inches	
	Min	Max	Min	Max
A	1.350	1.750	0.053	0.069
A1	0.100	0.250	0.004	0.010
A2	1.350	1.550	0.053	0.061
b	0.330	0.510	0.013	0.020
c	0.170	0.250	0.007	0.010
D	4.700	5.100	0.185	0.200
E	3.800	4.000	0.150	0.157
E1	5.800	6.200	0.228	0.244
e	1.270(BSC)		0.050(BSC)	
L	0.400	1.270	0.016	0.050
θ	0°	8°	0°	8°