



N-CHANNEL Trench Power MOSFET MEM2404

General Description

The MEM2404 combines advanced trench MOSFET technology with a low resistance package to provide extremely low RDS(ON). This device is ideal for power switching application and LED backlighting.

Features

- VDS=100V, ID=11A
- RDS(ON)<140mΩ@VGS=10V(Typ:68 mΩ)
- Ultra Low On-Resistance
- PACKAGE : TO252

Pin Configuration

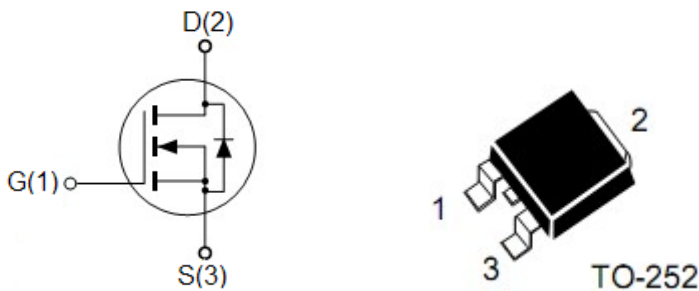

MEM2404K3G

Application

- Power switching application
- LED backlighting

Maximum Ratings(Ta=25°C)

Parameter	Symbol	Ratings	Unit
Drain-Source Voltage(VGS=0V)	V _{DSS}	100V	V
Gate-Source Voltage(VDS=0V)	V _{GSS}	±20	V
Drain Current	I _D	T _A =25°C	11
		T _A =100°C	7.7
Pulsed Drain Current (Note1)	I _{DM}	44	A
Total Power Dissipation	P _d	45	W
Single Pulse Avalanche Energy (Note2)	EAS	16	mJ
Operating Temperature Range	T _{Opr}	-55-175	°C
Storage Temperature Range	T _{stg}	-55-175	°C

Notes: 1.Repetitive Rating :Pulse width limited by maximum junction temperature.

2.EAS condition Topr =25°C, VDD=50V, V_G=10V, R_G=25Ω

Thermal Characteristics

Parameter	Symbol	TYP.	MAX.	Unit
Thermal Resistance,Junction-to-Case	R _{θJC}	-	3.3	°C/W

Electrical Characteristics(Ta=25°C)

Parameter	Symbol	Test Condition	Min	Type	Max	Unit	
Static Characteristics							
Drain-Source Breakdown Voltage	$V_{(BR)DSS}$	$V_{GS}=0V, I_D=250\mu A$	100	-	-	V	
Gate Threshold Voltage	$V_{GS(th)}$	$V_{DS}=V_{GS}, I_D=250\mu A$	1.0	2.0	3.0	V	
Gate-Body Leakage	I_{GSS}	$V_{DS}=0V, V_{GS}=\pm 20V$	-	-	± 100	nA	
Zero Gate Voltage Drain Current	I_{DSS}	$V_{DS}=100V$ $V_{GS}=0V$	$T_A=25^\circ C$	-	-	1	μA
			$T_A=100^\circ C$	-	-	5	μA
Static Drain-Source On-Resistance	$R_{DS(on)}$	$V_{GS}=10V, I_D=4.5A$	-	68	140	m Ω	
		$V_{GS}=4.5V, I_D=3A$	-	82	152	m Ω	
Dynamic Characteristics							
Forward Transconductance	g_{FS}	$V_{DS}=5V, I_D=4.5A$	12	-	-	S	
Input Capacitance	C_{iss}	$V_{DS}=50V,$ $V_{GS}=0V,$ $f=1MHz$	-	690	-	pF	
Output Capacitance	C_{oss}		-	44	-		
Reverse Transfer Capacitance	C_{rss}		-	30	-		
Total Gate Charge	Q_g	$V_{DS}=50V,$ $V_{GS}=10V,$ $I_D=4.5A$	-	13.4	-	nC	
Gate-Source Charge	Q_{gs}		-	3.2	-		
Gate-Drain Charge	Q_{gd}		-	6.2	-		
Source-Drain Diode Characteristics							
Source-Drain Current(Body Diode)	I_{SD}		-	11	-	A	
Pulsed Source-Drain Current(Body Diode)	I_{SD}		-	44	-	A	
Source-drain (diode forward) voltage(Note1)	V_{SD}	$T_A=25^\circ C, V_{GS}=0V, I_{SD}=1A$	-	0.75	1.0	V	
Reverse Recovery Time(Note1)	t_{rr}	$T_A=25^\circ C, I_F=4.5A, di/dt=100A/\mu A$	-	11	-	nS	
Reverse Recovery Charge(Note1)	Q_{rr}		-	14	-	nC	
Forward Turn-on Time	t_{on}	Intrinsic turn-on time is negligible(turn-on) is dominated by L_S+L_D					
Switching Characteristics							
Turn-On Delay Time	$t_{d(on)}$	$V_{DS}=50V,$ $R_G=8.6\Omega$ $V_{GS}=10V,$ $R_L=3\Omega$	-	7	-	nS	
Rise Time	t_r		-	12	-		
Turn-Off Delay Time	$t_{d(off)}$		-	24	-		
Fall-Time	t_f		-	11	-		

Notes 1. Pulse Test width $\leq 300\mu S$, Duty Cycle $\leq 1.5\%$, Starting $T_A=25^\circ C$

Typical performance characteristics

Figure1. On-Region Characteristics

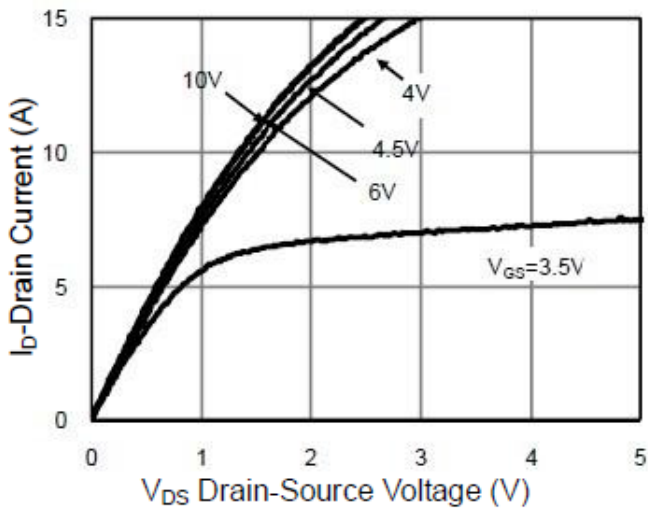

Figure 2: Transfer Characteristics

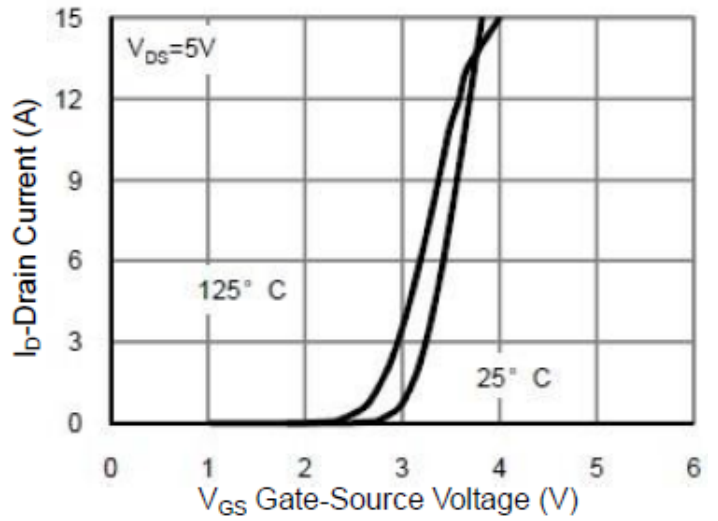

Figure3. ID vs Junction Temperature

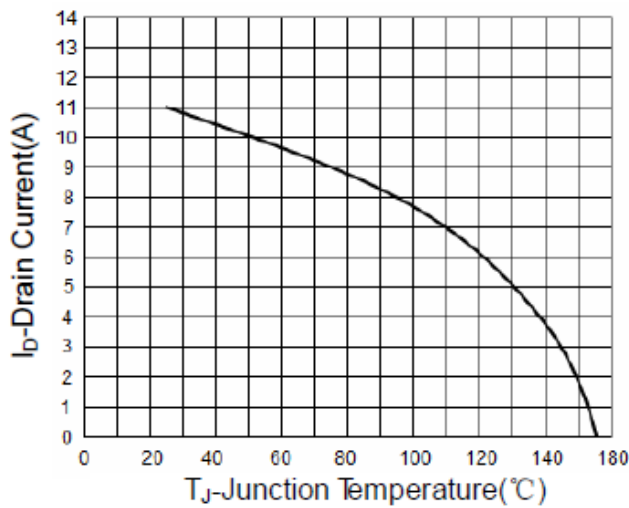

Figure4. On-Resistance vs. Junction Temperature

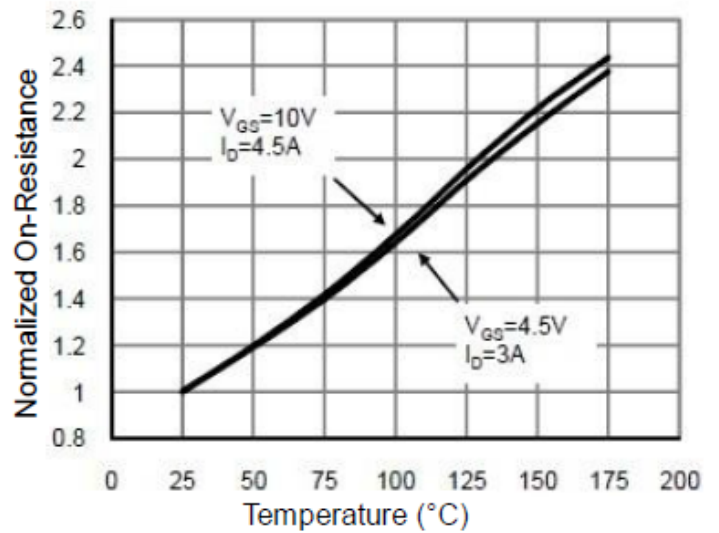

Figure5. On-Resistance vs. Gate-Source Voltage

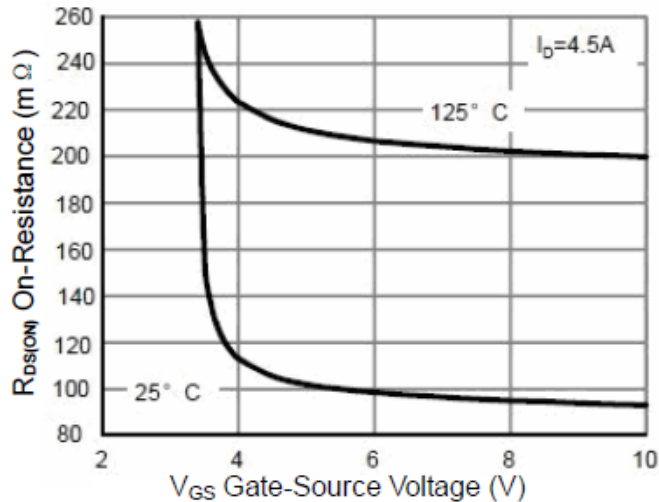

Figure6. Body-Diode Characteristics

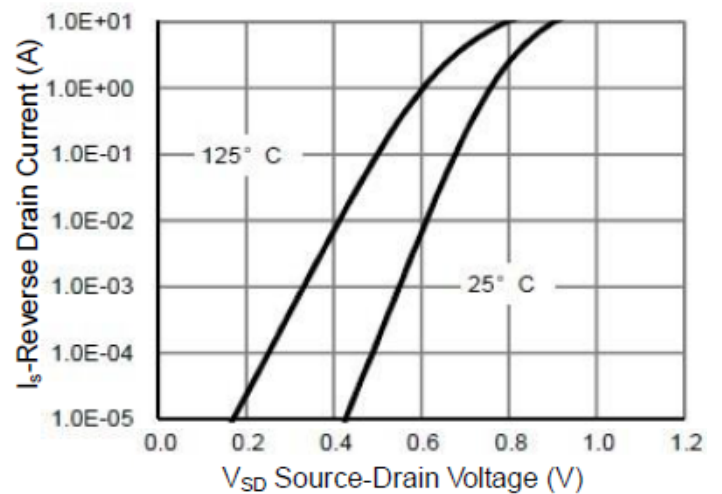

Figure7. Gate-Charge Characteristics

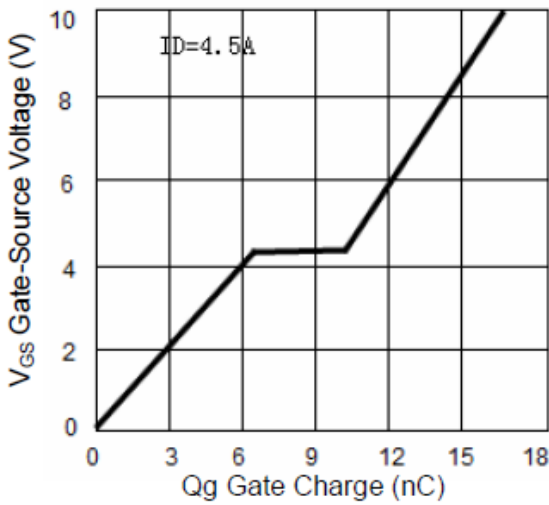

Figure 8. Capacitance Characteristics

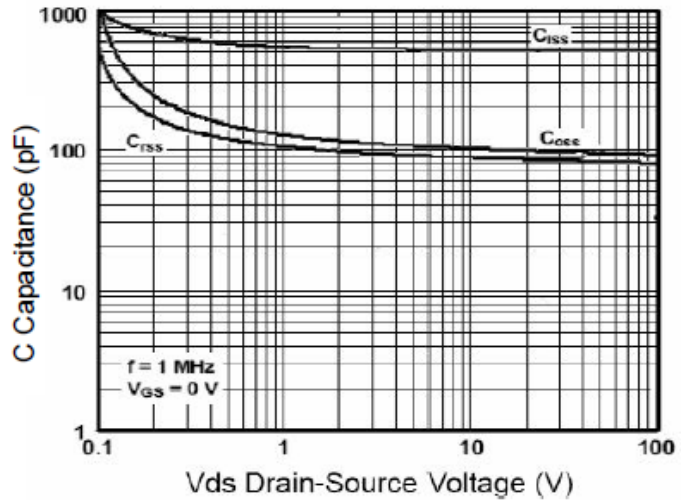

Figure 9. Maximum Forward Biased Safe Operating Area

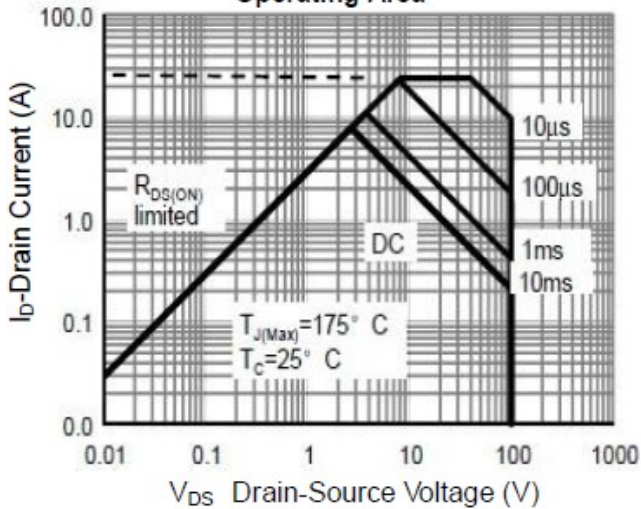

Figure10. Single Pulse Power Rating Junction-to-Case

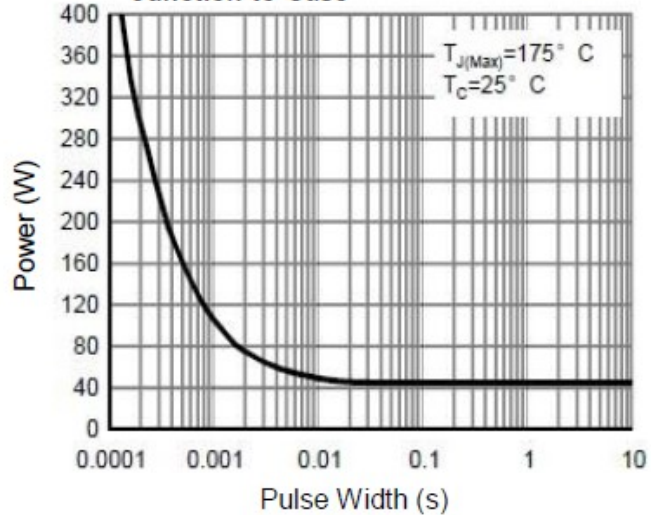
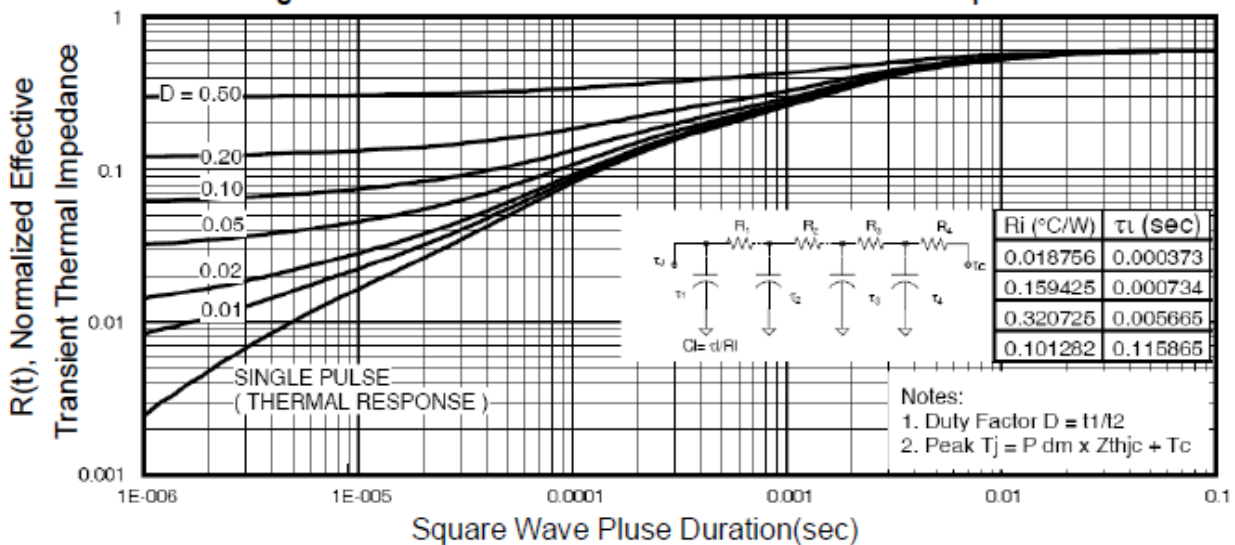
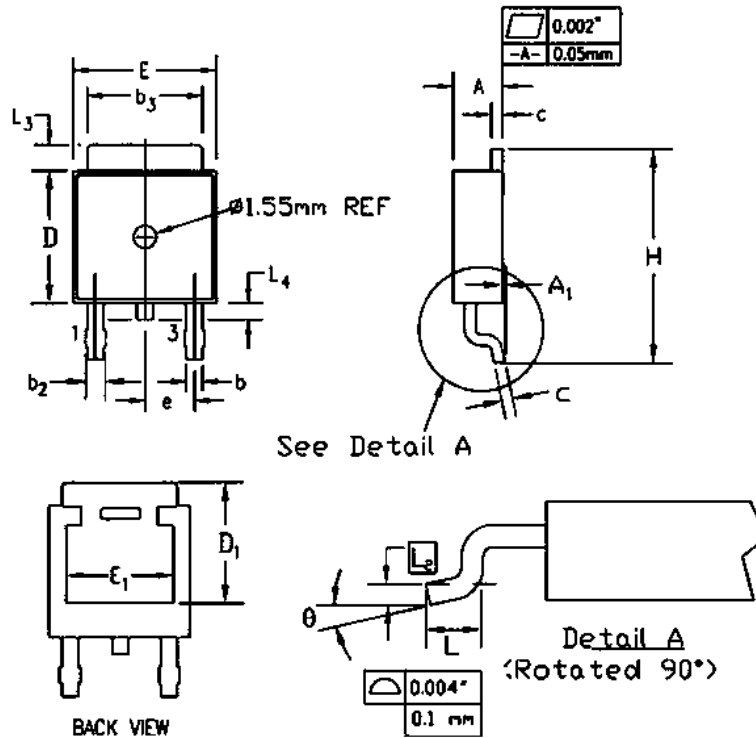

Figure11. Normalized Maximum Transient Thermal Impedance



Package Information

Package Type:TO-252



DIM	Millimeters		Inches	
	Min	Max	Min	Max
A	2.19	2.38	0.086	0.094
A1	-	0.13	-	0.005
b	0.64	0.89	0.025	0.035
b2	0.84	1.14	0.033	0.045
b3	5.21	5.46	0.205	0.215
c	0.46	0.61	0.018	0.024
D	5.97	6.22	0.235	0.250
D1	5.21	-	0.205	-
E	6.35	6.73	0.250	0.265
E1	4.83	-	0.190	-
e	2.29REF		0.090REF	
H	9.65	10.41	0.380	0.410
L	1.40	1.78	0.055	0.070
L2	0.51REF		0.020REF	
L3	0.89	1.27	0.035	0.050
L4	0.64	1.01	0.025	0.040
θ	0°	8°	0°	8°

- The information described herein is subject to change without notice.
- Nanjing Micro One Electronics Inc is not responsible for any problems caused by circuits or diagrams described herein whose related industrial properties, patents, or other rights belong to third parties. The application circuit examples explain typical applications of the products, and do not guarantee the success of any specific mass-production design.
- Use of the information described herein for other purposes and/or reproduction or copying without the express permission of Nanjing Micro One Electronics Inc is strictly prohibited.
- The products described herein cannot be used as part of any device or equipment affecting the human body, such as exercise equipment, medical equipment, security systems, gas equipment, or any apparatus installed in airplanes and other vehicles, without prior written permission of Nanjing Micro One Electronics Inc.
- Although Nanjing Micro One Electronics Inc exerts the greatest possible effort to ensure high quality and reliability, the failure or malfunction of semiconductor products may occur. The user of these products should therefore give thorough consideration to safety design, including redundancy, fire-prevention measures, and malfunction prevention, to prevent any accidents, fires, or community damage that may ensue.