



TAIWAN TONGJIA OPTOELECTRONICS TECHNOLOGY CO., LTD

GUANGDONG TONGJIA OPTOELECTRONICS TECHNOLOGY CO., LTD

承認書

Specification For Approval

Customer: (客戶) _____

Description: (產品描述) SMD5050燈珠RGBW正白

Part number: (產品型號) TJ-S5050UG3W5TLCRGBTW-A5

Date: (日期) _____

Approved By: (客戶承認)

--

Prepared By: (我司承認)

Approval	Check	Design	Sales

核准

審核

製作

業務

Customer Service Hotline: **400-676-8616**

TEL: 0769-8662 5999 0769-8200 2226

E-MAIL : dg@togialed.com

FAX: 0769-8200 2227

WEB: www.togialed.com

■ Outline Dimension:

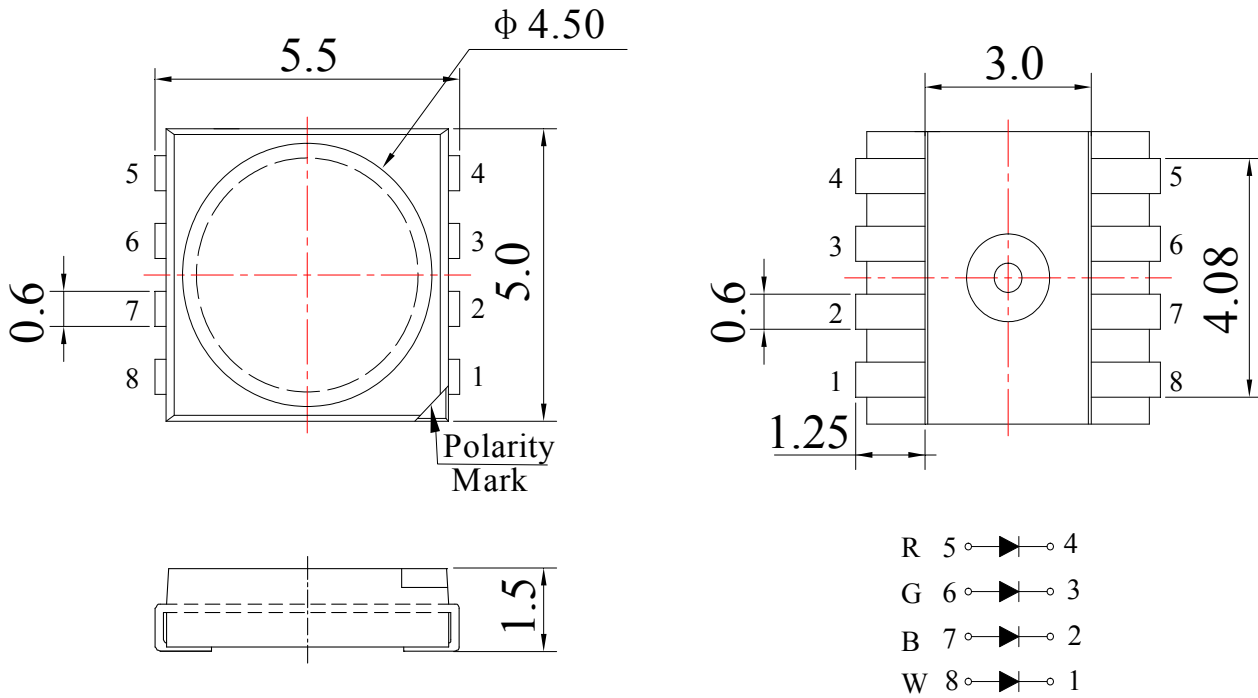

■ PAD Lay Out PCB

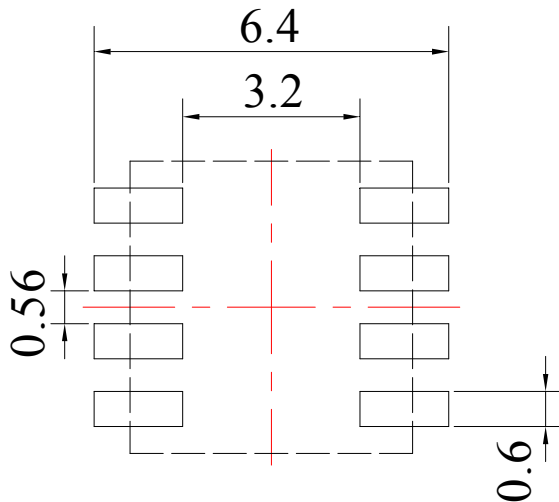

ATTENTION
OBSERVE PRECAUTIONS
FOR HANDLING
ELECTROSTATIC
SENSITIVE DEVICES

Notes:

1. All dimensions are in millimeters.
2. Tolerance is ± 0.2 unless otherwise noted.
3. Specifications are subject to change without notice.

■ Absolute Maximum Ratings (Ta = 25°C)

Items	Symbol	Absolute maximum Rating	Unit
Power Dissipation	P _D	308	mW
Forward Current(DC)	I _F	30	mA
Peak Forward Current	I _{FP}	100	mA
Reverse Voltage	V _R	5	V
Operation Temperature	T _{opr}	- 40~ + 85	°C
Storage Temperature	T _{stg}	- 40~ + 80	°C
Lead Soldering Temperature	T _{sol}	Max.260°C for 5 sec Max. (3min from the base of the epoxy bulb)	

Pulse width ≤ 0.1msec duty ≤ 1/10

■ Typical Electrical & Optical Characteristics(Ta=25°)

Items	Symbol	Condition	Min	Typ	Max	Unit
Forward Voltage	VF (I _F =20mA)	R	1.8	2.0	2.4	V
		G	2.8	3.0	3.4	V
		B	2.8	3.0	3.4	V
	VF(I _F =30mA)	W	2.8	3.0	3.4	V
Reverse Current	IR	VR =5V	---	---	2	μ A
Dominant Wavelength	λ d (I _F =20mA)	R	620	---	630	nm
		G	520	---	530	nm
		B	460	---	470	nm
Color Temperature	I _F =30mA	W	5500	---	7000	K
Luminous Intensity	I _v (I _F =20mA)	R	400	---	800	mcd
		G	1200	---	2200	mcd
		B	300	---	700	mcd
	I _v (I _F =30mA)	W	8	---	12	LM
View Angle	2 θ 1/2	I _F =20mA	---	120	---	Deg

Typical Electrical/Optical Characteristics Curves (R):

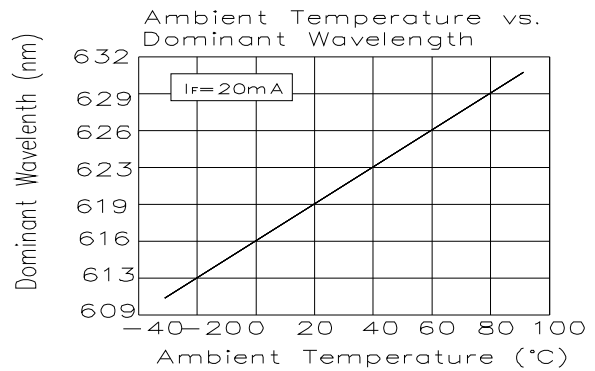
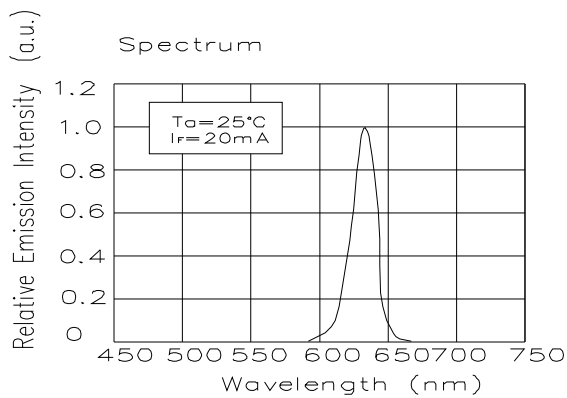
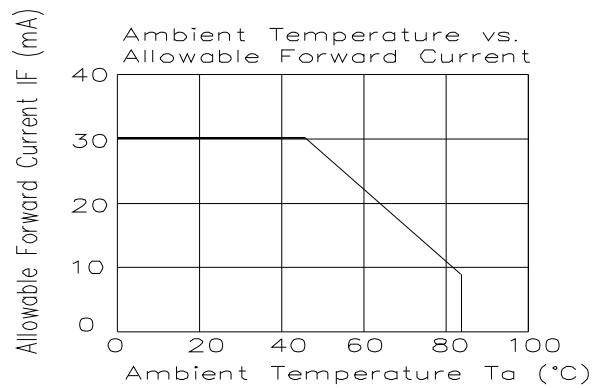
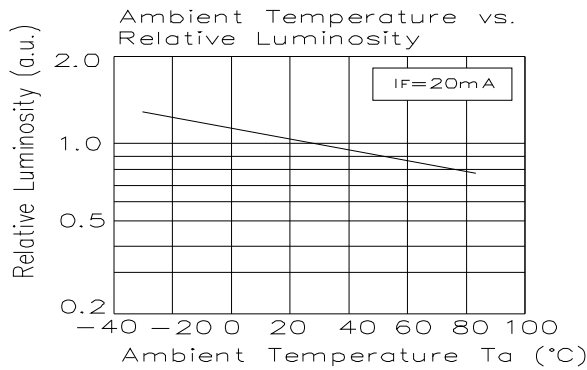
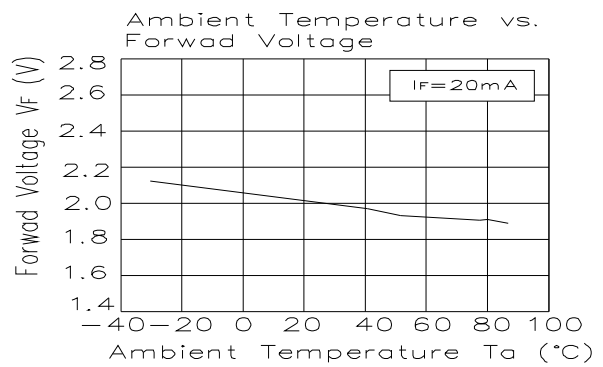
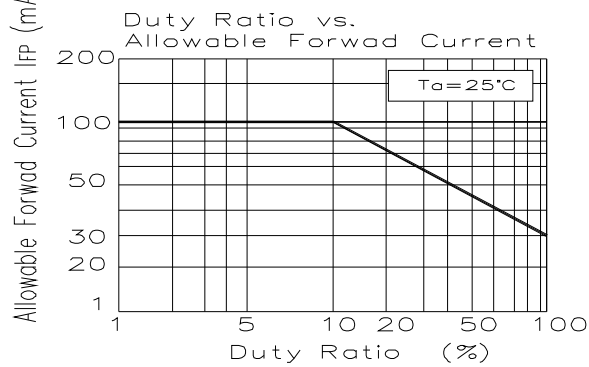
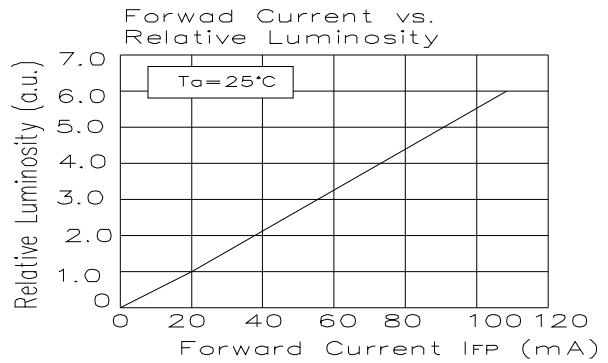
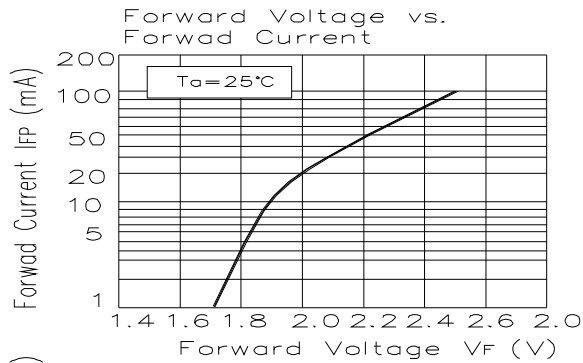

Typical Electrical/Optical Characteristics Curves (G):

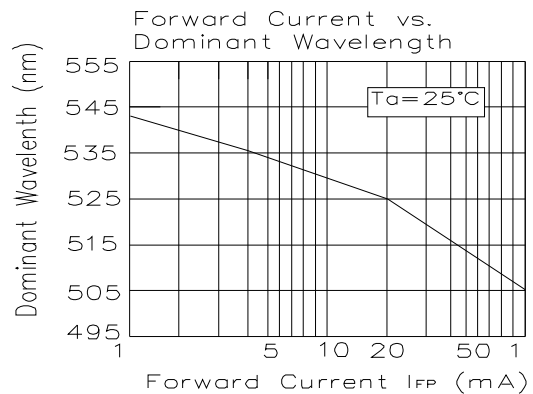
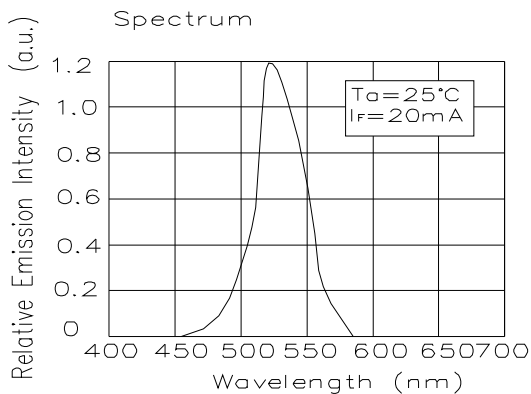
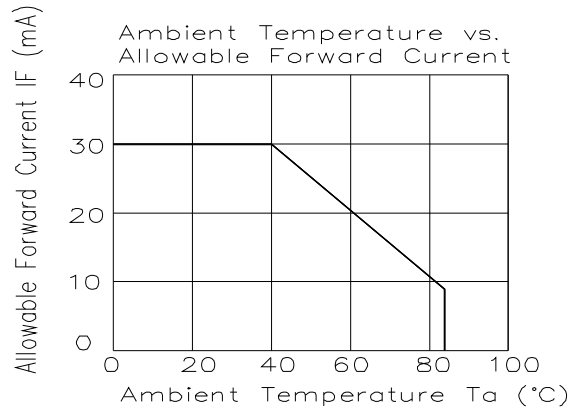
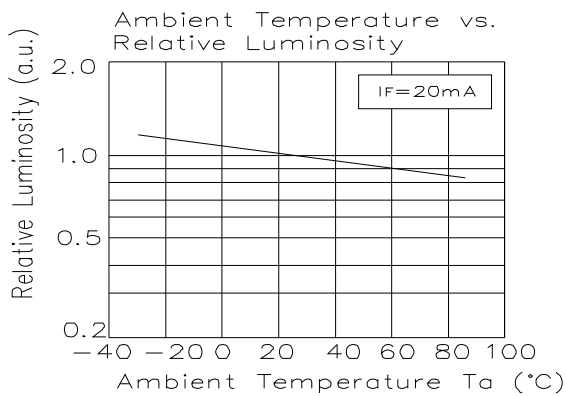
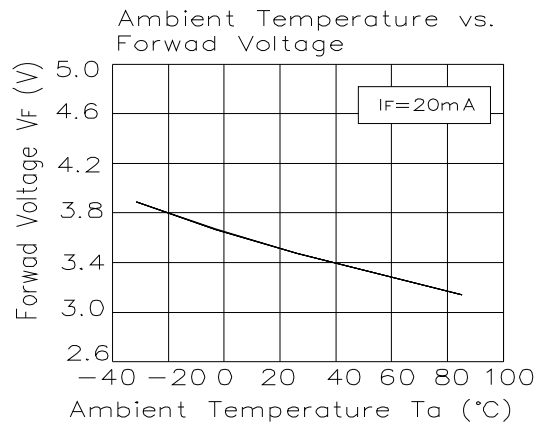
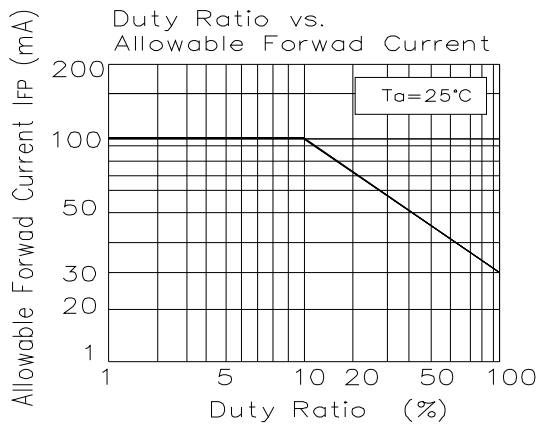
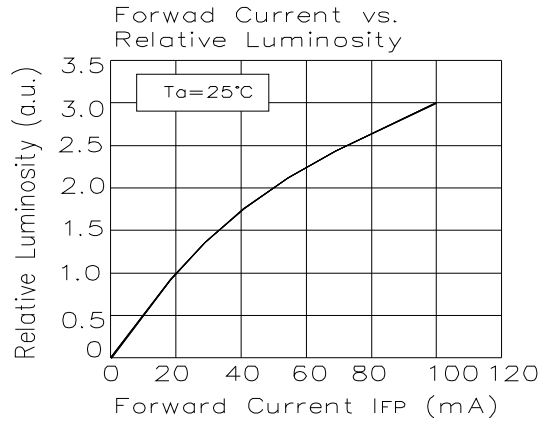
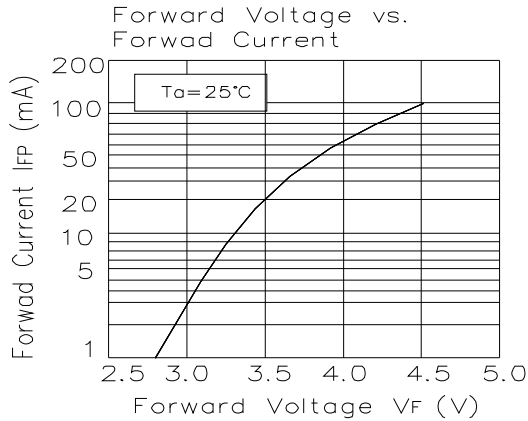

■ Typical Electrical/Optical Characteristics Curves (B):

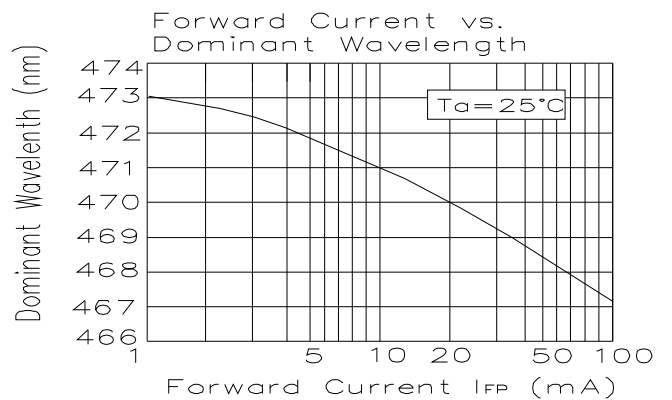
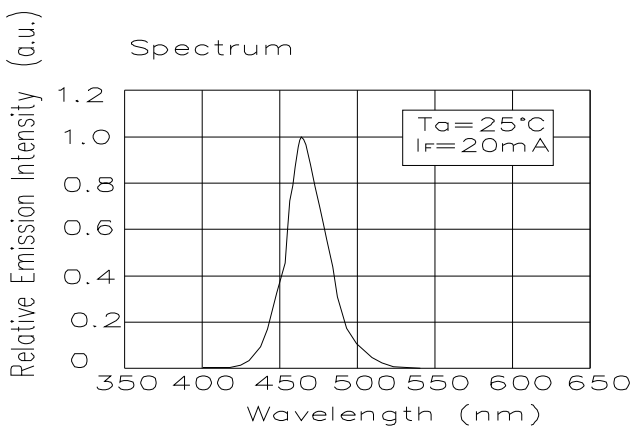
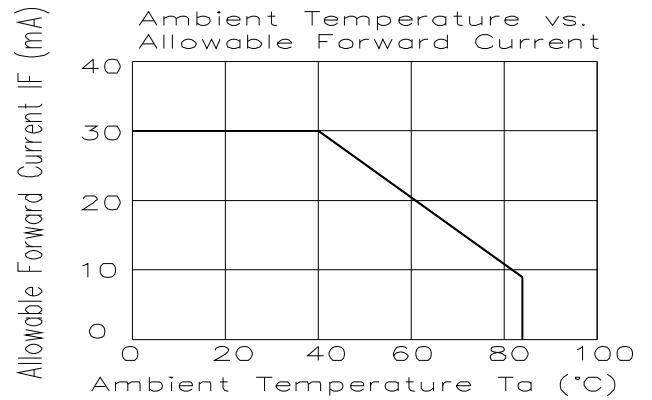
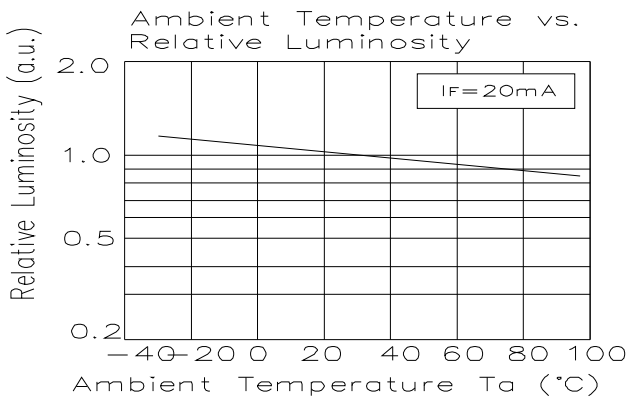
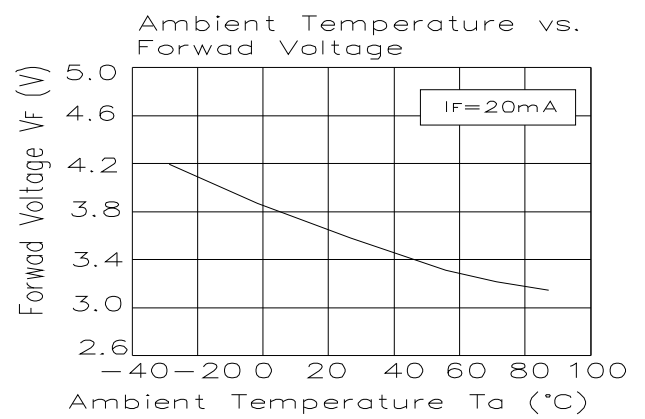
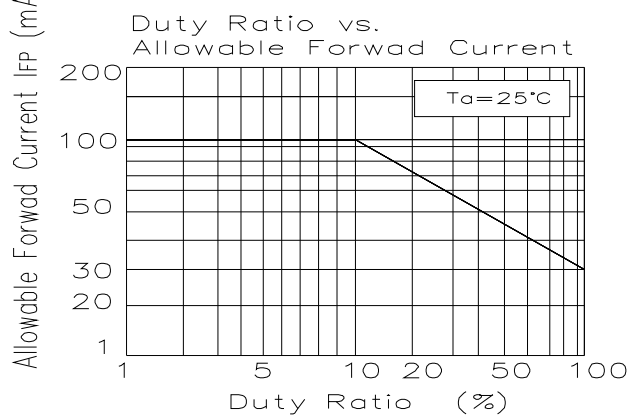
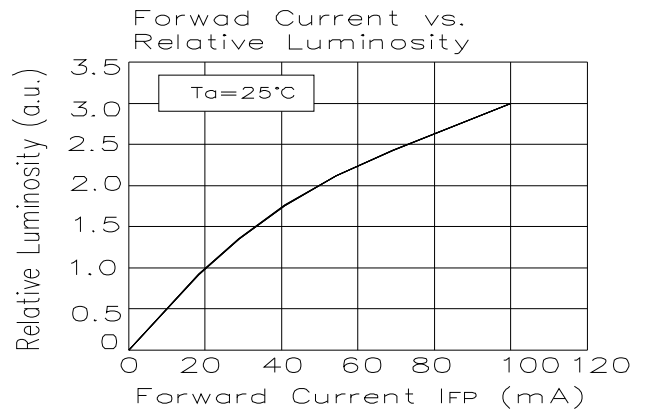
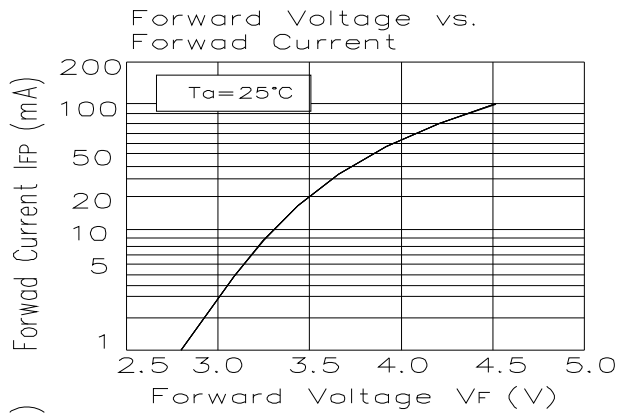

■ Typical Electrical/Optical Characteristics Curves (W):

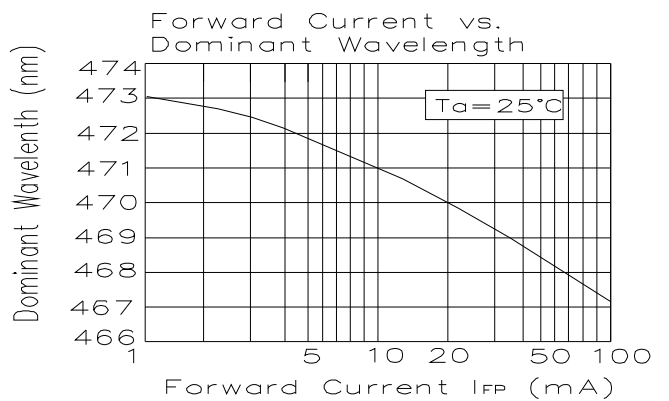
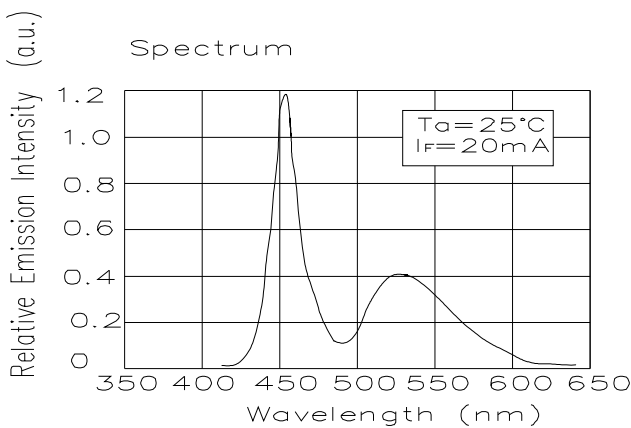
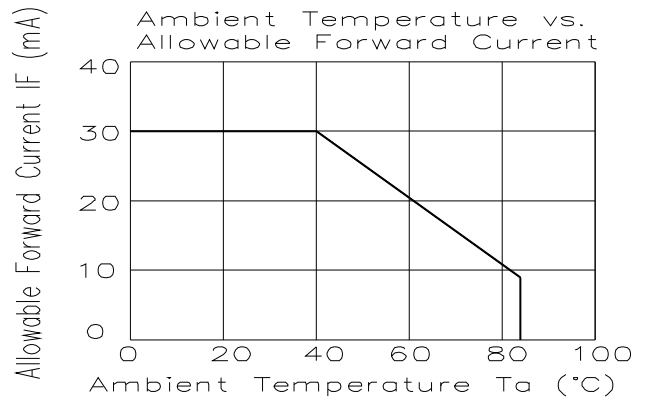
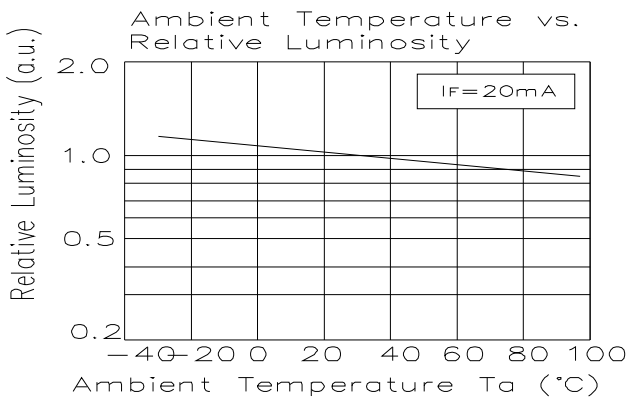
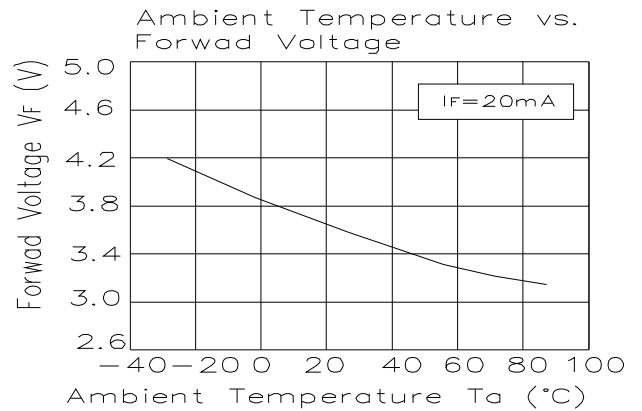
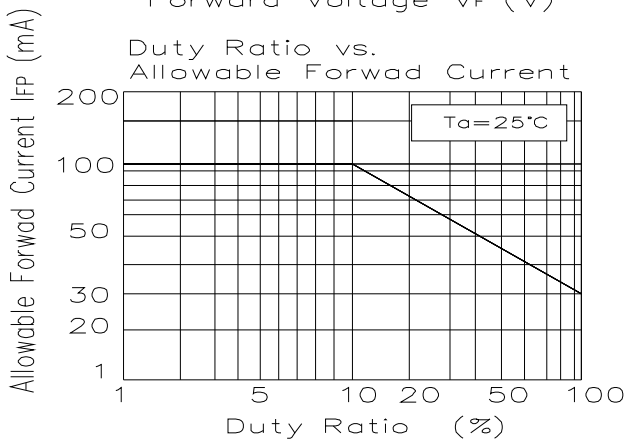
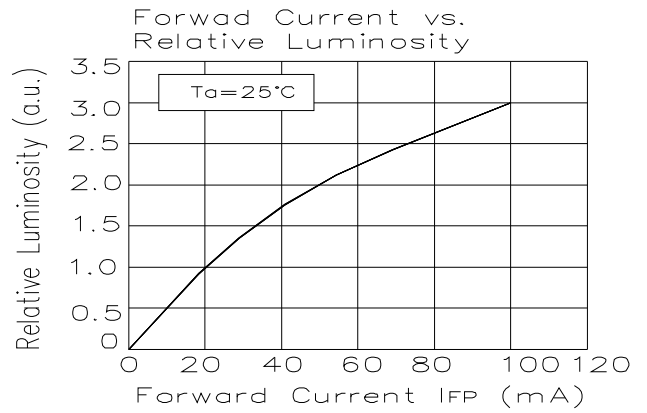
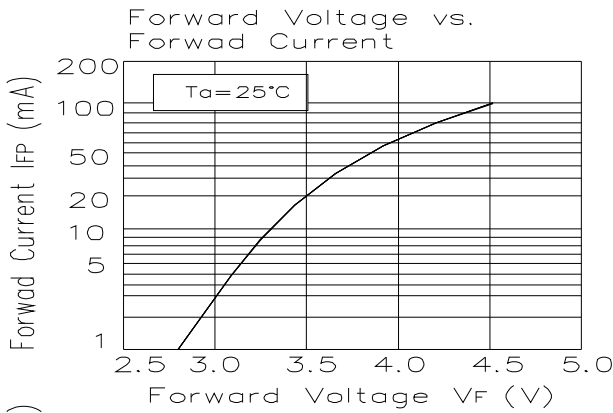

Classification	Test Item	Standard Test Method	Test Conditions	Duration	Units Tested	Number of Damaged
Life Test	Operating Life Test	JIS7021:B4 MIL-STD-202:107D MIL-STD-750:1026	T _A =25°C ± 5°C, I _F =30mA	1000h	22	0/22
Environment Test	High Temperature Storage	JIS7021:B10 MIL-STD-202:210A MIL-STD-750:2031	T _A =100°C ± 5°C	1000h	22	0/22
	Low Temperature Storage	JIS7021:B12	T _A = - 55°C ± 5°C	1000h	22	0/22
	Temp & Humidity Test	JIS7021:B11 MIL-STD-202:103D	T _A =85°C ± 5°C RH=85% ± 5%RH	1000h	22	0/22
	Thermal Shock Test	JIS7021:B4 MIL-STD-202:107D MIL-STD-750:1026	- 10°C ± 5°C ← → 100°C ± 5°C 5min - 5min	50 Cycles	22	0/22
	Temperature Cycling Test	JIS7021:A3 MIL-STD-202:107D MIL-STD-750:1051	- 55°C ~ 25°C ~ 85°C ~ 25°C 3min - 5min - 30min - 5min	50 Cycles	22	0/22
Mechanical Test	Resistance to Soldering Heat	JIS7021:A1 MIL-STD-202:210A MIL-STD-750:2031	260 ± 5°C, 10 ± 1sec	1 time	22	0/22
	Lead Integrity	MIL-STD-750D Method 2036.3	Load 2.5N 0° ~ 90° ~ 0°	3time	22	0/22

● **Soldering :**

1. Manual Soldering

The temperature of the iron tip should not be higher than 350°C and Soldering time to be within 3 seconds per solder-pad.

2. Reflow Soldering

Preheating : 140°C~160°C±5°C, within 2 minutes.

Operation heating : 260°C (Max.) within 10 seconds. (Max)

Gradual Cooling (Avoid quenching).

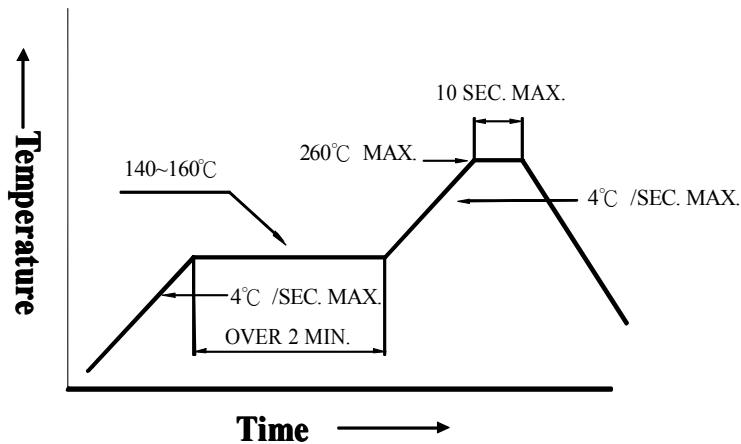

3. DIP soldering (Wave Soldering) :

Preheating : 120°C~150°C, within 120~180 sec.

Operation heating : 245°C±5°C within 5 sec. 260°C (Max)

Gradual Cooling (Avoid quenching).

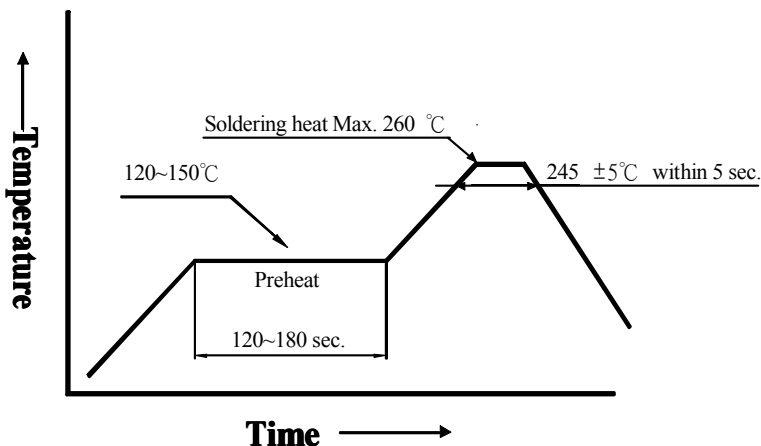

● **Handling :**

Care must be taken not to damage LED's epoxy resin while exposing to high temperature or contact LED's epoxy resin with hard or sharp objects, such as metal hook, tweezer or sand blasting.

● **Notes for designing:**

Current limiting resistor must be used in the circuit to drive TOGIA LEDs within the rated figures and not to overload TOGIA LEDs with instantaneous voltage at the turning ON and OFF cycles.

When using pulse driving, the average current must be within the rated figures. And the circuit should be designed to avoid reverse voltage when turning off the TOGIA LEDs.

● **Storage:**

In order to avoid the absorption of moisture, it is recommended to solder TOGIA LEDs as soon as possible after unpacking the sealed envelope.

If the envelope is still packed, to store it in the environment as following:

- (1) Temperature : 5°C-30°C(41°F) Humidity : RH 60% Max.
- (2) After this bag is opened, devices that will be applied to infrared reflow, vapor-phase reflow, or equivalent soldering process must be:
 - a. Completed within 168 hours.
 - b. Stored at less than 30% RH.
- (3) Devices require baking before mounting, if:
 - (2) a or (2) b is not met.
- (4) If baking is required, devices must be baked under below conditions:
48 hours at 60°C±3°C.

● **Package and Label of Products:**

Package: Products are packed in one bag of 1000 pcs (one taping reel) and a label is attached to each bag.

