



Features

- Low power consumption
- Low voltage drop
- Low temperature coefficient
- Low Quiescent Current: 3uA at 6V
- Output voltage accuracy: tolerance $\pm 2\%$

Applications

- Battery-powered equipment
- Reference voltage sources
- Cameras, video cameras
- Portable AV systems
- Mobile phones
- Portable games

General Description

PL6206 series are a highly precise, lower consumption, 3 terminal, positive voltage regulators manufactured using CMOS and laser trimming technologies. The series provides large currents with a significantly small dropout voltage.

The PL6206 consists of a current limiter circuit, a driver transistor, a precision reference voltage and an error correction circuit. The series is

compatible with low ESR ceramic capacitors. The current limiter's foldback circuit operates as a short circuit protection as well as the output current limiter for the output pin. Output voltages are internally by laser trimming technologies. It is selectable in 0.1V increments within a range of 1.2V to 5.0V. PL6206 series are available in SOT-23, SOT23-3 and SOT-89 packages.

Typical Application

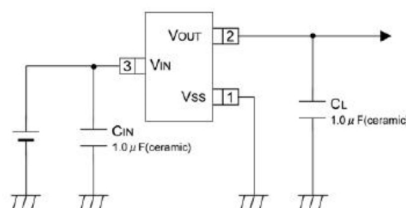

Order Information

PL 6206-①②③④

Designator	Symbol	Description
①②	Integer	Output Voltage(1.2~5.0V)
③	N	Package:SOT23
	M	Package:SOT23-3
	P	Package:SOT89A
	P1	Package:SOT89B
④	R	RoHS / Pb Free
	G	Halogen Free

Note: "①②" stands for output voltages. Other voltages can be specially customized



Block Diagram

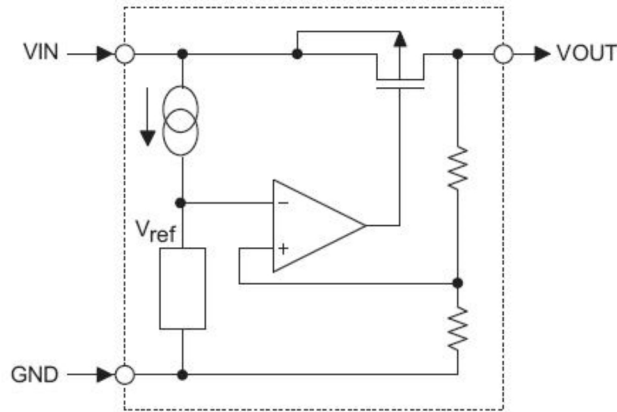

Pin Assignment

SOT23-3 and SOT23
(Top view)

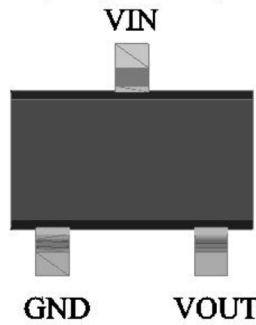

SOT89 A (Top view)

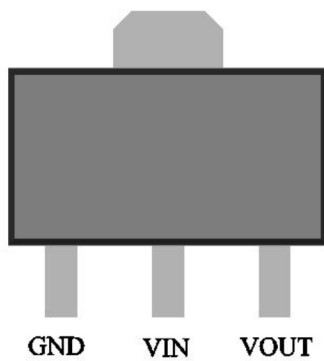

SOT89 B (Top view)

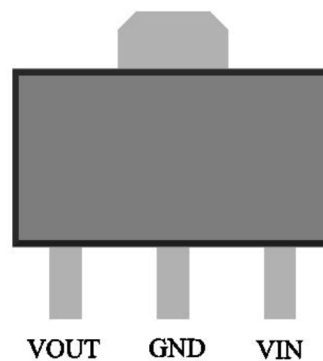



Marking Rule

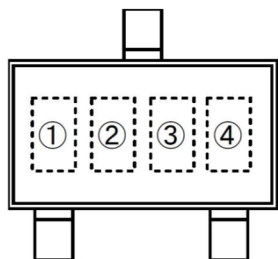

SOT-23
(TOP VIEW)

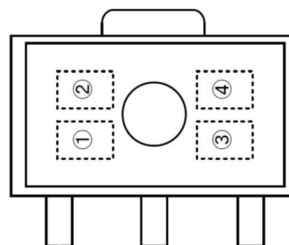

SOT-89
(TOP VIEW)

① represents product number

MARK	PRODUCT SERIES
6	PL 6206****

② represents 3 pins regulator

MARK		PRODUCT SERIES
VOLTAGE=0.1~3.0V	VOLTAGE=3.1V~6.0V	
5	6	PL 6206

③ represents output voltage

MARK	VOLTAGE(V)			MARK	VOLTAGE(V)		
0	-	3.1	-	F	1.6	4.6	-
1	-	3.2	-	H	1.7	4.7	-
2	-	3.3	-	K	1.8	4.8	-
3	-	3.4	-	L	1.9	4.9	-
4	-	3.5	-	M	2.0	5.0	-
5	-	3.6	-	N	2.1	-	-
6	-	3.7	-	P	2.2	-	-
7	-	3.8	-	R	2.3	-	-
8	-	3.9	-	S	2.4	-	-
9	-	4.0	-	T	2.5	-	-
A	-	4.1	-	U	2.6	-	-
B	1.2	4.2	-	V	2.7	-	-
C	1.3	4.3	-	X	2.8	-	-
D	1.4	4.4	-	Y	2.9	-	-
E	1.5	4.5	-	Z	3.0	-	-

④ X



Absolute Maximum Ratings

Parameter	Symbol	Ratings	Units	
Input Voltage	V _{IN}	8	V	
Output Current	I _{OUT}	300*	mA	
Output Voltage	V _{OUT}	V _{SS} -0.3~V _{IN} +0.3	V	
Power Dissipation	SOT-23	P _d	0.20	W
	SOT23-3		0.25	W
	SOT-89		0.50	W
	USP-6B		0.10	W
	TO-92		0.50	W
Operating Temperature Range	T _{opr}	-40~+85	°C	
Storage Temperature Range	T _{stg}	-55~+125	°C	

*I_{OUT}=P_d/(V_{IN}-V_{OUT})

Electrical Characteristics

PL 6206 for any output voltage

(Ta=25°C)

Parameter	Symbol	Conditions	Min.	Typ.	Max.	Unit
Output Voltage	V _{out}	V _{in} =V _{out} +1V 1.0mA≤I _{out} ≤30mA	V _{out} ×0.98	--	V _{out} ×1.02	V
Output Current*1	I _{out}	V _{in} -V _{out} =1V	--	300	--	mA
Low dropout*2	V _{drop}	Refer to the next table				
Line Regulation	ΔV _{out1} /(V _{in} -V _{out})	1.6V≤V _{in} ≤8V I _{out} =40mA	--	0.05	0.2	%/V
Load Regulation	ΔV _{out} / ΔI _{out}	V _{in} = V _{out} +1V 1.0mA≤I _{out} ≤80mA	--	12	30	mV
Output voltage Temperature Coefficiency	ΔV _{out} /(Ta-V _{out})	I _{out} =30mA 0°C≤Ta≤70°C	--	±100	--	Ppm/°C
Supply Current	I _{ss}	--	--	3	5	uA
Input Voltage	V _{in}	--	--	6	8	V
PSRR	PSRR	F=1KHz V _{in} =V _{out} +1V	--	50	--	dB
Output Noise	EN	BW=10Hz~100KHz	--	30	--	uVrms



Electrical Characteristics by Output Voltage:

Output Voltage Vout(V)	Dropout Voltage Vdif (V)		
	Conditions	Typ.	Max.
Vout≤1.5V	Iout=100 mA	0.35	0.57
1.8 ≤ Vout ≤ 2		0.28	0.42
2.8 ≤ Vout ≤ 5.0		0.19	0.35

Typical Performance Characteristics

(1) Output Voltage vs Input voltage and Output Voltage vs. Output Current and Input Transient Response

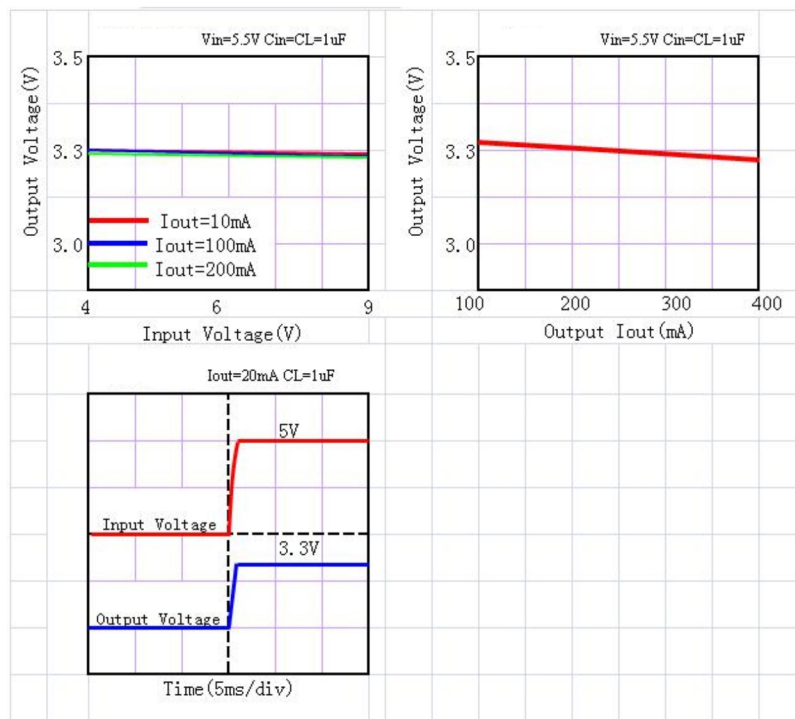

(2) Output Voltage vs. Ambient Temperature

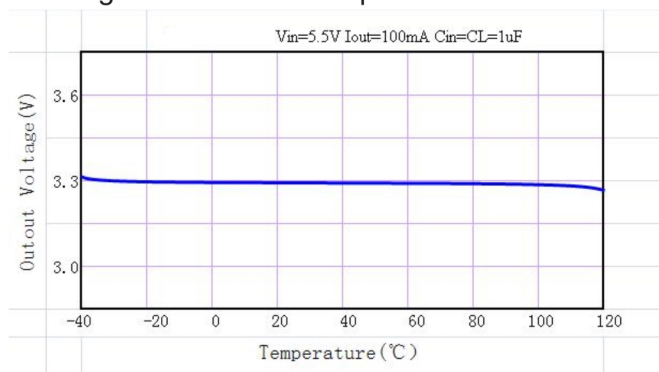



Package Information

3-pin SOT23 Outline Dimensions

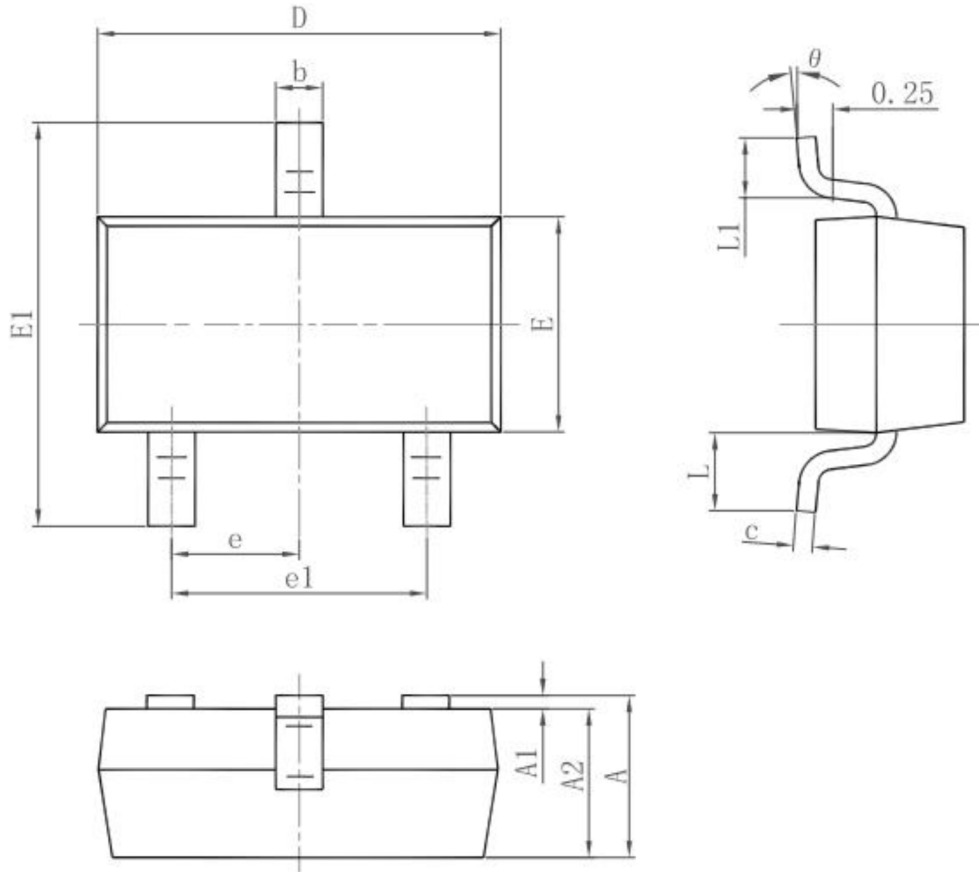

Symbol	Dimensions In Millimeters		Dimensions In Inches	
	Min.	Max.	Min.	Max.
A	0.900	1.150	0.035	0.045
A1	0.000	0.100	0.000	0.004
A2	0.900	1.050	0.035	0.041
b	0.300	0.500	0.012	0.020
c	0.080	0.150	0.003	0.006
D	2.800	3.000	0.110	0.118
E	1.200	1.400	0.047	0.055
E1	2.250	2.550	0.089	0.100
e	0.950 TYP.		0.037 TYP.	
e1	1.800	2.000	0.071	0.079
L	0.550 REF.		0.022 REF.	
L1	0.300	0.500	0.012	0.020
θ	0°	8°	0°	8°



3-pin SOT23-3 Outline Dimensions

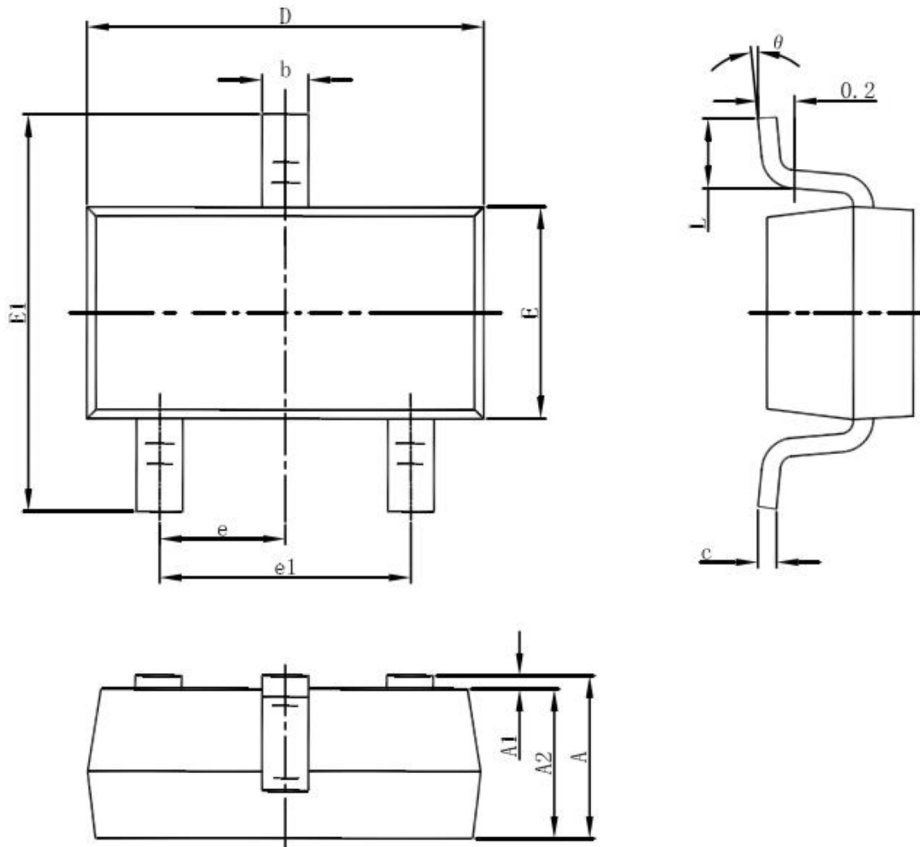

Symbol	Dimensions In Millimeters		Dimensions In Inches	
	Min	Max	Min	Max
A	1.050	1.250	0.041	0.049
A1	0.000	0.100	0.000	0.004
A2	1.050	1.150	0.041	0.045
b	0.300	0.500	0.012	0.020
c	0.100	0.200	0.004	0.008
D	2.820	3.020	0.111	0.119
E	1.500	1.700	0.059	0.067
E1	2.650	2.950	0.104	0.116
e	0.950(BSC)		0.037(BSC)	
e1	1.800	2.000	0.071	0.079
L	0.300	0.600	0.012	0.024
theta	0°	8°	0°	8°



3-pin SOT89 Outline Dimensions

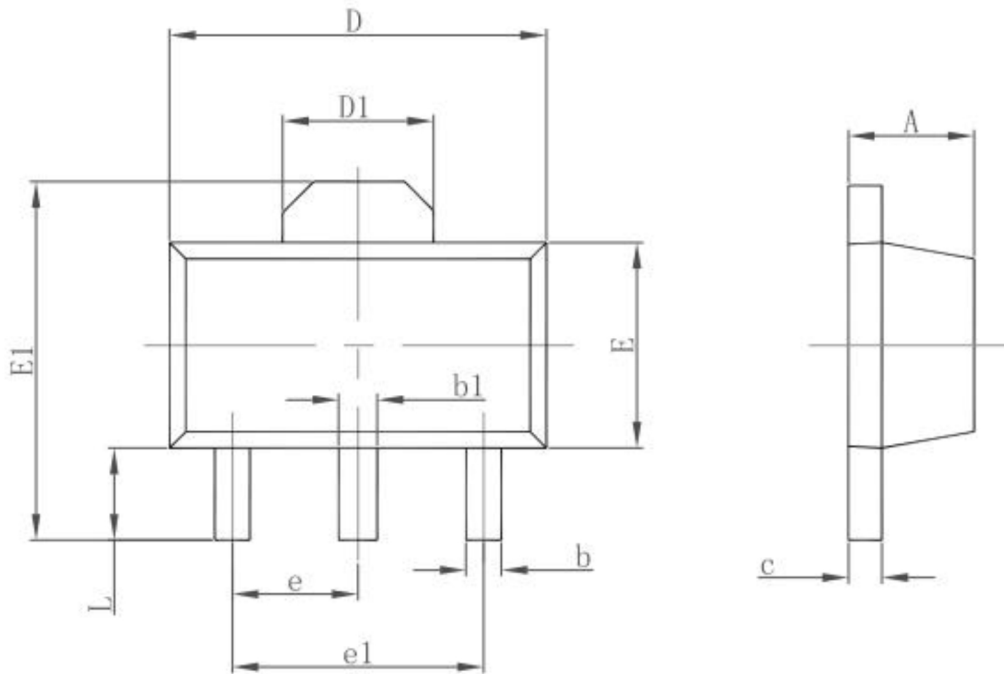

Symbol	Dimensions In Millimeters		Dimensions In Inches	
	Min.	Max.	Min.	Max.
A	1.400	1.600	0.055	0.063
b	0.320	0.520	0.013	0.020
b1	0.400	0.580	0.016	0.023
c	0.350	0.440	0.014	0.017
D	4.400	4.600	0.173	0.181
D1	1.550 REF.		0.061 REF.	
E	2.300	2.600	0.091	0.102
E1	3.940	4.250	0.155	0.167
e	1.500 TYP.		0.060 TYP.	
e1	3.000 TYP.		0.118 TYP.	
L	0.900	1.200	0.035	0.047