



1SMA4728A THRU 1SMA200A

Zener Voltage - 3.3 to 200 Volts Peak Pulse Power - 1.0 W

ZENER DIODES

Features

- ◆ For surface mounted applications in order to optimize board space
- ◆ Low profile package
- ◆ Built-in strain relief
- ◆ Glass passivated junction
- ◆ Low inductance
- ◆ Typical I_R less than $5.0\mu A$ above 11V
- ◆ High temperature soldering guaranteed:
260°C / 10 seconds at terminals
- ◆ Plastic package has Underwriters Laboratory Flammability Classification 94V-0

DO-214AC/SMA

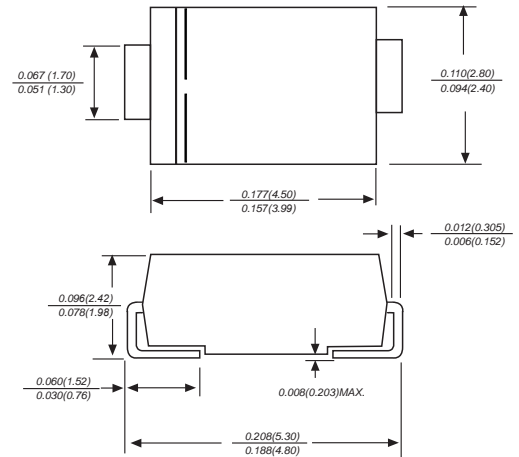

Dimensions in inches and (millimeters)

Mechanical Data

- Case** : JEDEC DO-214AC/SMA Molded plastic body
Terminals : Solder plated, solderable per MIL-STD-750, Method 2026
Polarity : Polarity symbol marking on body
Mounting Position : Any
Weight : 0.002ounce, 0.07grams
Standard packing : 12mm tape(E1A-481)

Maximum Ratings And Electrical Characteristics

Ratings at 25°C ambient temperature unless otherwise specified.			
MDD Catalog Number	SYMBOLS	VALUE	UNITS
Peak Power Dissipation at $T_A=50^\circ C$, Derate above 50 °C (Note 1)	P_D	1.0 6.67	Watts mW/°C
Peak Forward Surge Current, 8.3 ms Single Half Sine-wave Superimposed on Rated Load (JEDEC method) (Note 2)	I_{FSM}	10.0	A
Operating and Storage Temperature Range	T_J, T_{STG}	-55 to + 150	°C

- Notes: 1. Mounted on $5.0mm^2$ (0.013mm thick) land areas.
 2. Measured on 8.3ms Single Half Sine-wave or Equivalent Square Wave,
 Duty Cycle=4 Pulses Per Minute Maximum.



1SMA4728A THRU 1SMA200A

Zener Voltage - 3.3 to 200 Volts Peak Pulse Power - 1.0 W

Ratings And Characteristic Curves

ELECTRICAL CHARACTERISTICS (TA=25°C unless otherwise noted) VF=1.2V max, IF=200mA for all types.

Part Number	V _Z @ I _{ZT}			Maximum Zener Impedance				Maximum Leakage Current		Marking Code	Package
				Z _{ZT} @ I _{ZT}		Z _{ZK} @ I _{ZK}		I _R @ V _R			
	Nom. V	Min. V	Max. V	Ω	mA	Ω	mA	μA	V		
1.0 Watt ZENER Diodes -- continued											
1SMA4728	3.3	3.1	3.5	10.0	76.0	400	1.00	100	1.0	728A	SMA
1SMA4729	3.6	3.4	3.8	10.0	69.0	400	1.00	100	1.0	729A	SMA
1SMA4730	3.9	3.7	4.1	9.0	64.0	400	1.00	50	1.0	730A	SMA
1SMA4731	4.3	4.1	4.5	9.0	58.0	400	1.00	10	1.0	731A	SMA
1SMA4732	4.7	4.5	4.9	8.0	53.0	500	1.00	10	1.0	732A	SMA
1SMA4733	5.1	4.8	5.4	7.0	49.0	550	1.00	10	1.0	733A	SMA
1SMA4734	5.6	5.3	5.9	5.0	45.0	600	1.00	10	2.0	734A	SMA
1SMA4735	6.2	5.9	6.5	2.0	41.0	700	1.00	10	3.0	735A	SMA
1SMA4736	6.8	6.5	7.1	3.5	37.0	700	1.00	10	4.0	736A	SMA
1SMA4737	7.5	7.1	7.9	4.0	34.0	700	0.50	10	5.0	737A	SMA
1SMA4738	8.2	7.8	8.6	4.5	31.0	700	0.50	10	6.0	738A	SMA
1SMA4739	9.1	8.6	9.6	5.0	28.0	700	0.50	10	7.0	739A	SMA
1SMA4740	10.0	9.5	10.5	7.0	25.0	700	0.25	10	7.6	740A	SMA
1SMA4741	11.0	10.5	11.6	8.0	23.0	700	0.25	5.0	8.4	741A	SMA
1SMA4742	12.0	11.4	12.6	9.0	21.0	700	0.25	5.0	9.1	742A	SMA
1SMA4743	13.0	12.4	13.7	10.0	19.0	700	0.25	5.0	9.9	743A	SMA
1SMA4744	15.0	14.3	15.8	14.0	17.0	700	0.25	5.0	11.4	744A	SMA
1SMA4745	16.0	15.2	16.8	16.0	15.5	700	0.25	5.0	12.2	745A	SMA
1SMA4746	18.0	17.1	18.9	20.0	14.0	750	0.25	5.0	13.7	746A	SMA
1SMA4747	20.0	19.0	21.0	22.0	12.5	750	0.25	5.0	15.2	747A	SMA
1SMA4748	22.0	20.9	23.1	23.0	11.5	750	0.25	5.0	16.7	748A	SMA
1SMA4749	24.0	22.8	25.2	25.0	10.5	750	0.25	5.0	18.2	749A	SMA
1SMA4750	27.0	25.7	28.4	35.0	9.5	750	0.25	5.0	20.6	750A	SMA
1SMA4751	30.0	28.5	31.5	40.0	8.5	1000	0.25	5.0	22.8	751A	SMA
1SMA4752	33.0	31.4	34.7	45.0	7.5	1000	0.25	5.0	25.1	752A	SMA
1SMA4753	36.0	34.2	37.8	50.0	7.0	1000	0.25	5.0	27.4	753A	SMA
1SMA4754	39.0	37.1	41	60.0	6.5	1000	0.25	5.0	29.7	754A	SMA
1SMA4755	43.0	40.9	45.2	70.0	6.0	1500	0.25	5.0	32.7	755A	SMA
1SMA4756	47.0	44.7	49.4	80.0	5.5	1500	0.25	5.0	35.8	756A	SMA
1SMA4757	51.0	48.5	53.6	95.0	5.0	1500	0.25	5.0	38.8	757A	SMA
1SMA4758	56.0	53.2	58.8	110	4.5	2000	0.25	5.0	42.6	758A	SMA
1SMA4759	62.0	58.9	65.1	125	4.0	2000	0.25	5.0	47.1	759A	SMA
1SMA4760	68.0	64.6	71.4	150	3.7	2000	0.25	5.0	51.7	760A	SMA
1SMA4761	75.0	71.3	78.8	175	3.3	2000	0.25	5.0	56.0	761A	SMA
1SMA4762	82.0	77.9	86.1	200	3.0	3000	0.25	5.0	62.2	762A	SMA
1SMA4763	91.0	86.5	95.6	250	2.8	3000	0.25	5.0	69.2	763A	SMA
1SMA4764	100	95.0	105	350	2.5	3000	0.25	5.0	76.0	100A	SMA
1SMA110A	110	104.5	115.5	450	2.3	4000	0.25	5.0	83.6	110A	SMA
1SMA120A	120	114	126	550	2.0	4500	0.25	5.0	91.2	120A	SMA
1SMA130A	130	123.5	136.5	700	1.9	5000	0.25	5.0	98.8	130A	SMA
1SMA150A	150	142.5	157.5	1000	1.7	6000	0.25	5.0	114.0	150A	SMA
1SMA160A	160	152	168	1100	1.6	6500	0.25	5.0	121.6	160A	SMA
1SMA180A	180	171	189	1200	1.4	7000	0.25	5.0	136.8	180A	SMA
1SMA200A	200	190	210	1500	1.2	8000	0.25	5.0	152.0	200A	SMA



1SMA4728A THRU 1SMA200A

Zener Voltage - 3.3 to 200 Volts Peak Pulse Power - 1.0 W

FIG.1- POWER TEMPERATURE DERATING CURVE

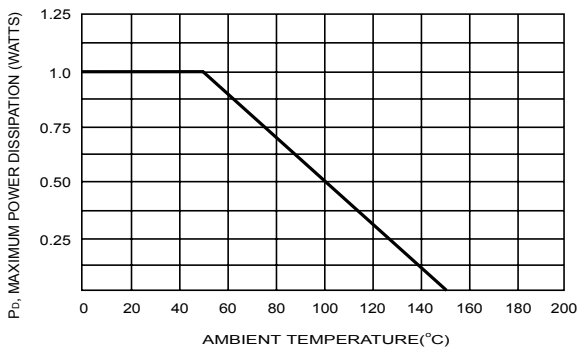

FIG.2- TYPICAL FORWARD CHARACTERISTICS

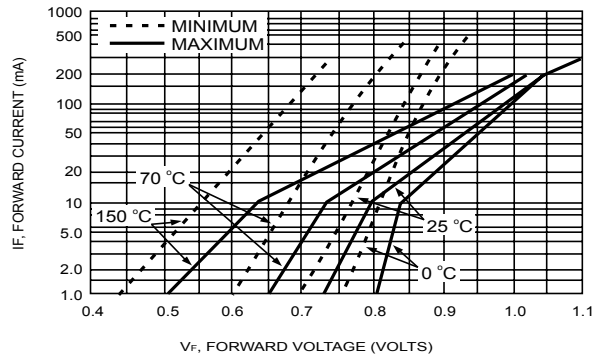

FIG.3- EFFECT OF ZENER CURRENT ON ZENER IMPEDANCE

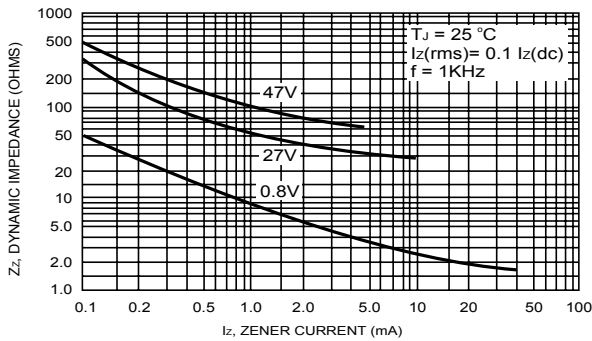

FIG.5- TYPICAL LEAKAGE CURRENT

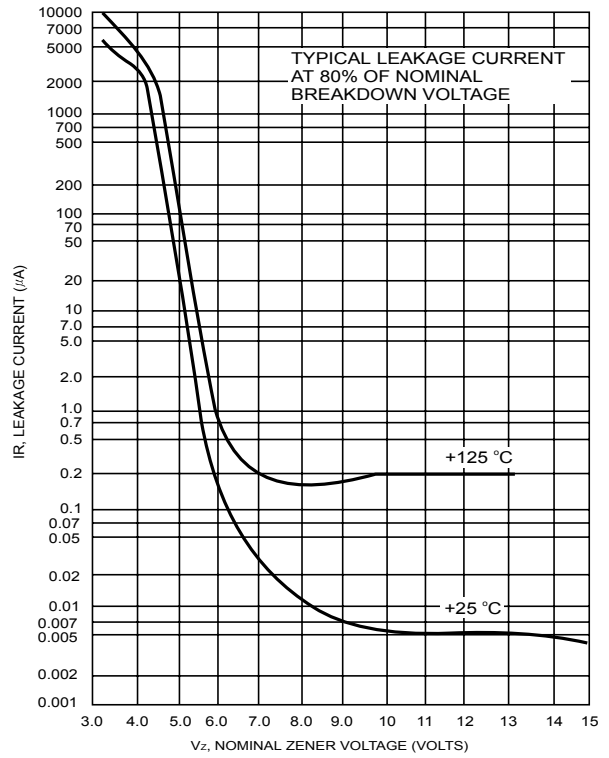

FIG.4- EFFECT OF ZENER VOLTAGE ON ZENER IMPEDANCE

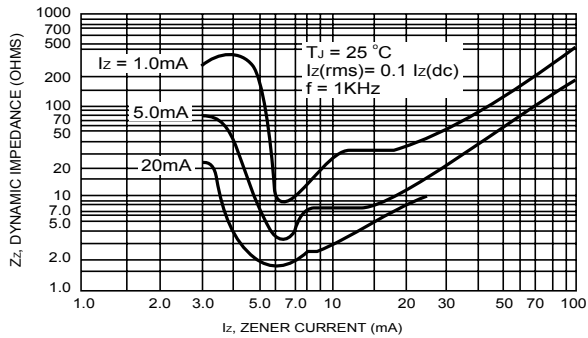

FIG.6- TYPICAL CAPACITANCE versus V_Z

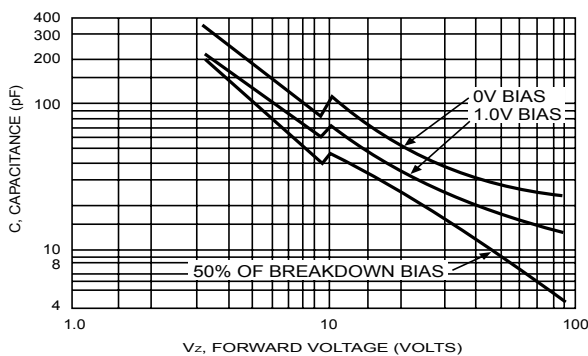
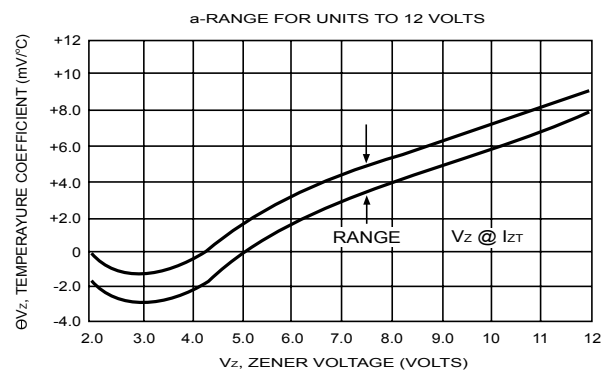

FIG.7- TEMPERATURE COEFFICIENTS



The cruve graph is for reference only



1SMA4728A THRU 1SMA200A

Zener Voltage - 3.3 to 200 Volts Peak Pulse Power - 1.0 W

FIG.7- TEMPERATURE COEFFICIENTS

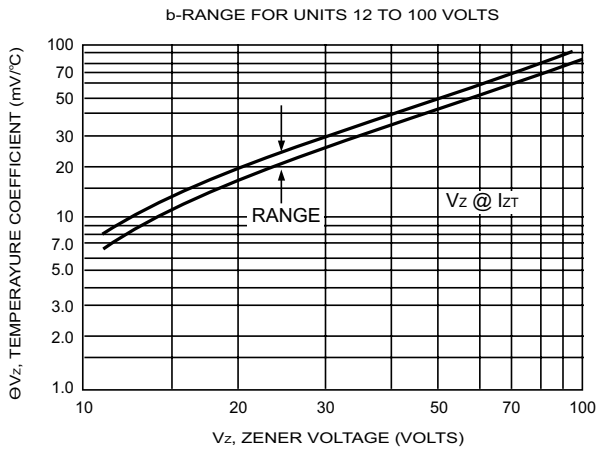

FIG.8- EFFECT OF ZENER CURRENT

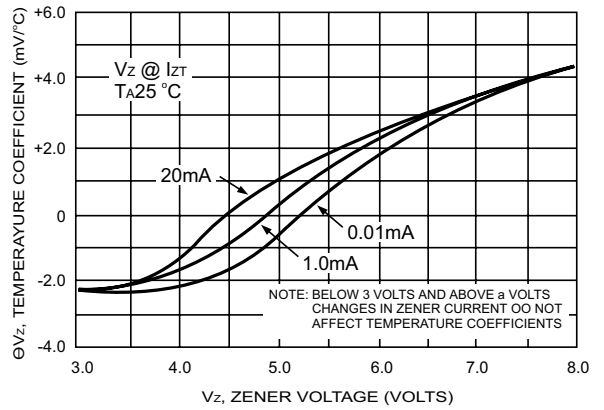
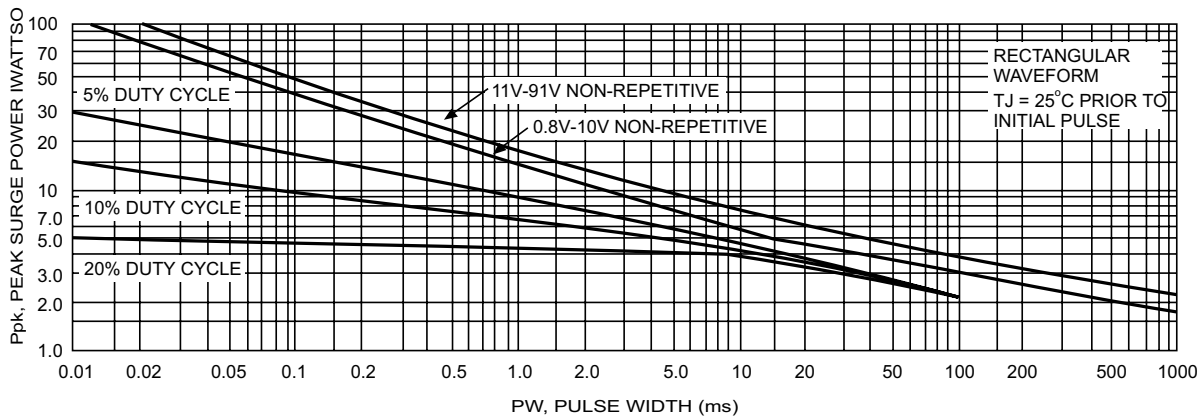

FIG.9- MAXIMUM SURGE POWER



The cruve graph is for reference only



1SMA4728A THRU 1SMA200A

Zener Voltage - 3.3 to 200 Volts Peak Pulse Power - 1.0 W

Packing information

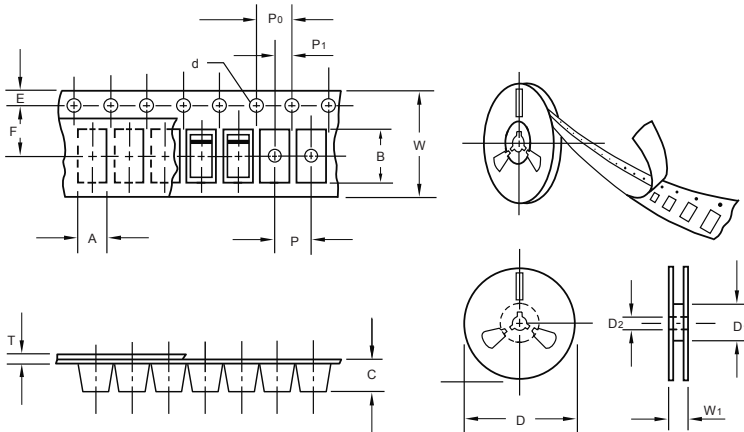

Item	Symbol	Tolerance	SMA
Carrier width	A	0.1	2.80
Carrier length	B	0.1	5.33
Carrier depth	C	0.1	2.36
Sprocket hole	d	0.05	1.50
13" Reel outside diameter	D	2.0	330.00
13" Reel inner diameter	D ₁	min	50.00
7" Reel outside diameter	D	2.0	178.00
7" Reel inner diameter	D ₁	min	62.00
Feed hole diameter	D ₂	0.5	13.00
Sprocket hole position	E	0.1	1.75
Punch hole position	F	0.1	5.50
Punch hole pitch	P	0.1	4.00
Sprocket hole pitch	P ₀	0.1	4.00
Embossment center	P ₁	0.1	2.00
Overall tape thickness	T	0.1	0.28
Tape width	W	0.3	12.00
Reel width	W ₁	1.0	18.00

Note: Devices are packed in accordance with EIA standard RS-481-A and specifications listed above.

Reel packing

PACKAGE	REEL SIZE	REEL (pcs)	COMPONENT SPACING (m/m)	BOX (pcs)	INNER BOX (m/m)	REEL DIA. (m/m)	CARTON SIZE (m/m)	CARTON (pcs)	APPROX. GROSS WEIGHT (kg)
SMA	7"	2,000	4.0	4,000	183*155*183	178	382*356*392	80,000	12.0
SMA	11"	5,000	4.0	10,000	290*290*38	330	310*310*360	80,000	11.0
SMA	13"	7,500	4.0	15,000	335*335*38	330	350*330*360	120,000	14.5

Suggested Pad Layout

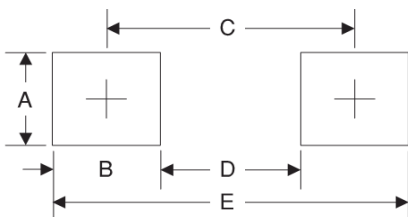

Symbol	Unit (mm)	Unit (inch)
A	1.68	0.066
B	1.52	0.060
C	3.90	0.154
D	2.41	0.095
E	5.45	0.215

Important Notice and Disclaimer

Microdiode Electronics (Jiangsu) reserves the right to make changes to this document and its products and specifications at any time without notice. Customers should obtain and confirm the latest product information and specifications before final design, purchase or use.

Microdiode Electronics (Jiangsu) makes no warranty, representation or guarantee regarding the suitability of its products for any particular purpose, nor does Microdiode Electronics (Jiangsu) assume any liability for application assistance or customer product design. Microdiode Electronics (Jiangsu) does not warrant or accept any liability with products which are purchased or used for any unintended or unauthorized application.

No license is granted by implication or otherwise under any intellectual property rights of Microdiode Electronics (Jiangsu).

Microdiode Electronics (Jiangsu) products are not authorized for use as critical components in life support devices or systems without express written approval of Microdiode Electronics (Jiangsu).